

Xinger®

Ultra Low Profile 0805 Power Divider 50Ω to 50Ω

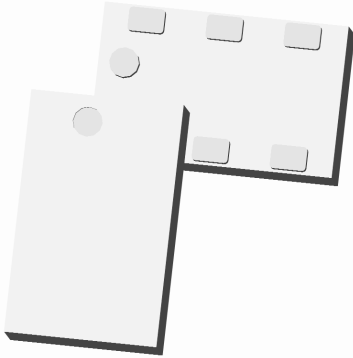

Description

The PD3150J5050S2HF is a low profile, sub-miniature Wilkinson power divider in an easy to use surface mount package. The PD3150J5050S2HF is ideal for high volume manufacturing and delivers higher performances than traditional printed and lumped element solutions. The PD3150J5050S2HF is matched to 50Ω and has a height profile of 0.5 mm which is ideal for high level integrations in the following markets: DVB-S, GSM, DCS, PCS, WCDMA and GPS, 802.11a+g, Bluetooth, and Zigbee USA.

The PD3150J5050S2HF does not include the resistive element and therefore, requires an external resistor for operation. The PD3150J5050S2HF is available on tape and reel for high volume manufacturing pick and place.

Detailed Electrical Specifications: Specifications subject to change without notice.

Features:	Parameter	ROOM (25°C)									Unit
		Min.	Typ.	Max	Min.	Typ.	Max	Min.	Typ.	Max	
• 2300-5000 MHz	Frequency	2300		3800	3400		3800	3100		5000	MHz
• 0.5mm Height Profile	Input Port Impedance		50			50			50		Ω
• 50Ω Input / 50Ω Outputs	Output Port Impedance		50			50			50		Ω
• Low Insertion Loss	Return Loss	6	7		10	15		6.3	8.6		dB
• Surface Mountable	Insertion Loss*		1.0	1.6		0.4	1.0		1.0	1.6	dB
• Tape & Reel	Amplitude Balance		0.3	0.5		0.1	0.4		0.1	0.4	dB
• Non-conductive Surface	Phase Balance		1	4		0.5	2		1	2	Degrees
• RoHS Compliant	Isolation (Output Ports)	11	13		17	25		13	15		dB
• Halogen Free	Power Handling@105°C			3			3			3	Watts
• External Resistor required	Operating Temperature	-55		+140	-55		+140	-55		+140	°C

* Insertion Loss stated at room temperature (Insertion Loss is approximately 0.1 dB higher at +85 °C)

Outline Drawing

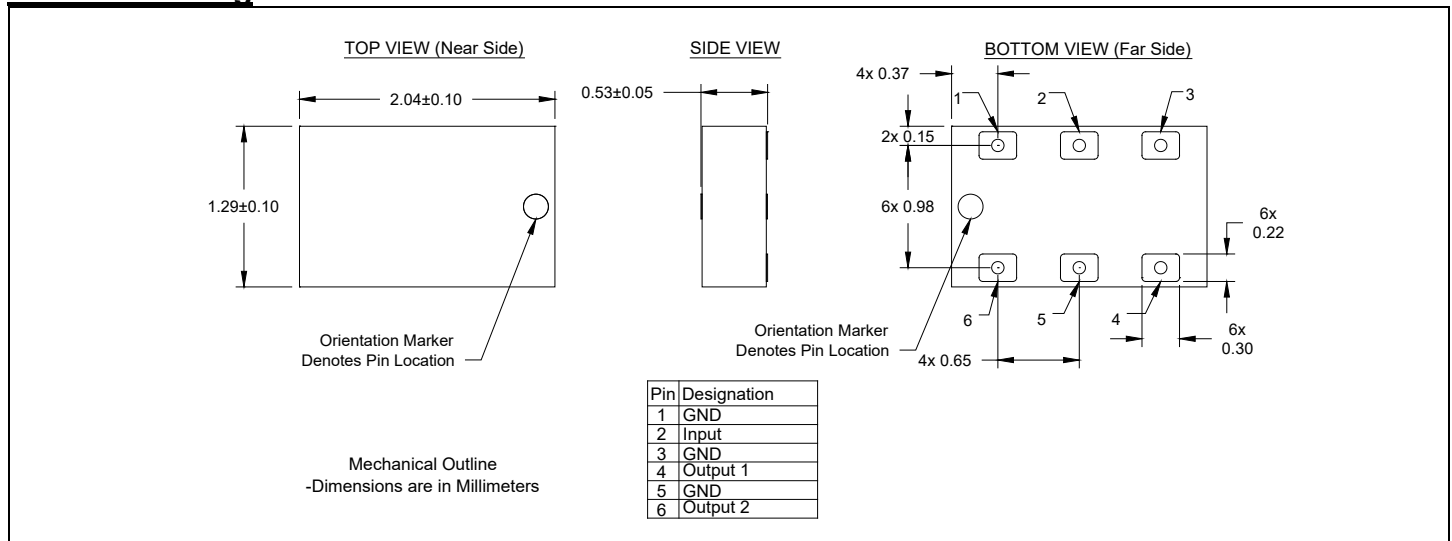

Typical Broadband Performance: 500 MHz. to 8.0 GHz.

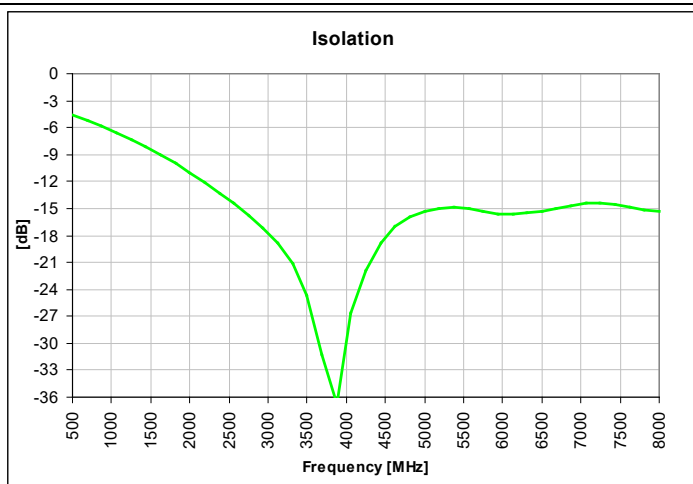
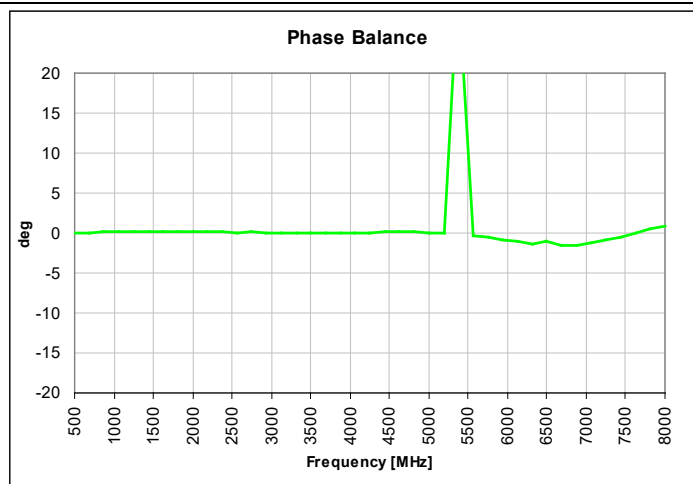
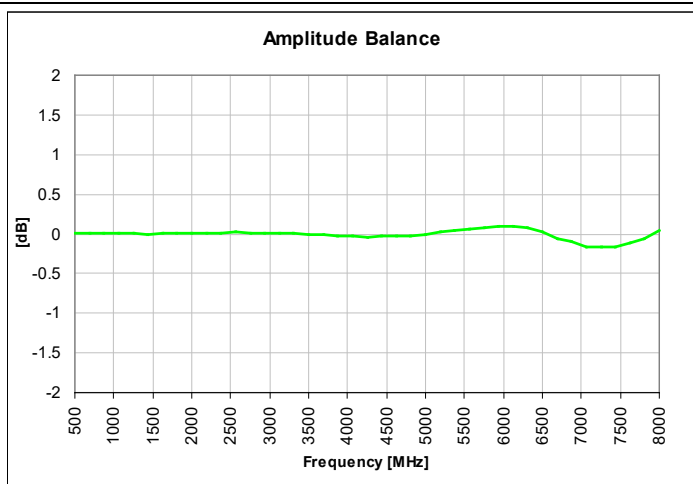
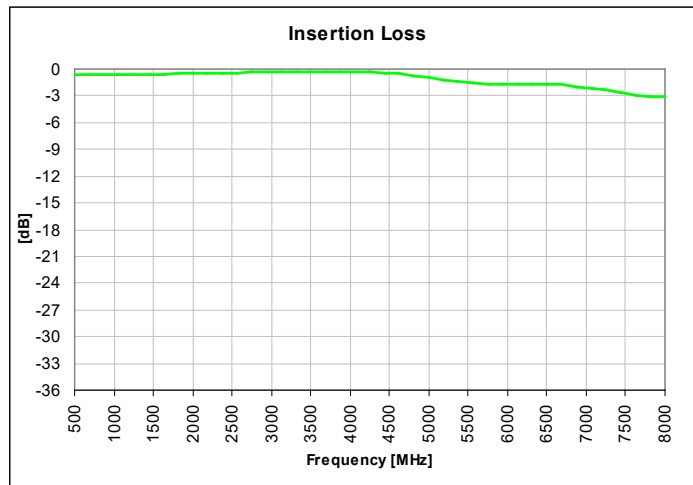
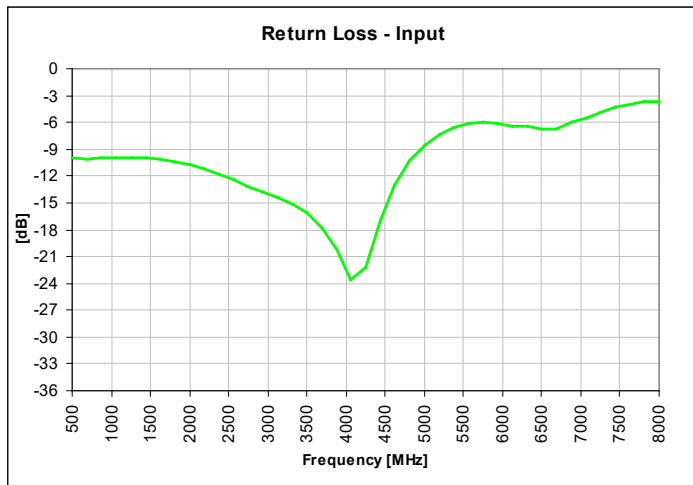

Typical Performance: 3000 MHz. to 5100 MHz.

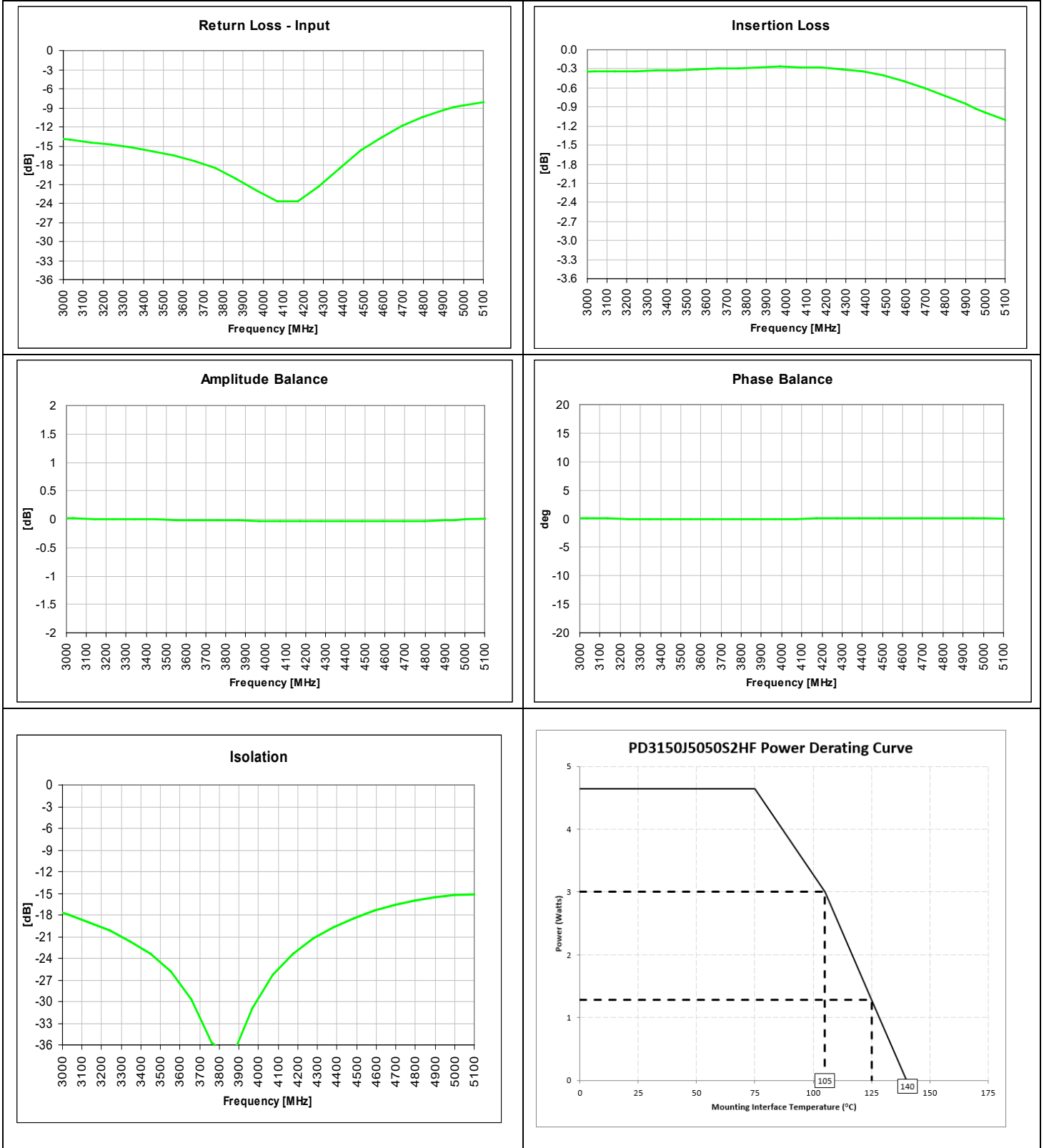

Mounting Configuration:

In order for Xinger surface mount components to work optimally, the proper impedance transmission lines must be used to connect to the RF ports. If this condition is not satisfied, insertion loss, Isolation and VSWR may not meet published specifications.

All of the Xinger components are constructed from organic PTFE based composites which possess excellent electrical and mechanical stability. Xinger components are compliant to a variety of ROHS and Green standards and ready for Pb-free soldering processes. Pads are Gold plated with a Nickel barrier.

An example of the PCB footprint used in the testing of these parts is shown below. In specific designs, the transmission line widths need to be adjusted to the unique dielectric coefficients and thicknesses as well as varying pick and place equipment tolerances. In addition, since the PD3150J5050S2HF is a Wilkinson power divider, an external 0603 100Ω resistor must be mounted in locations R1 as shown in the Figure below.

Pad Footprint w/ 0603 Resistor Locations

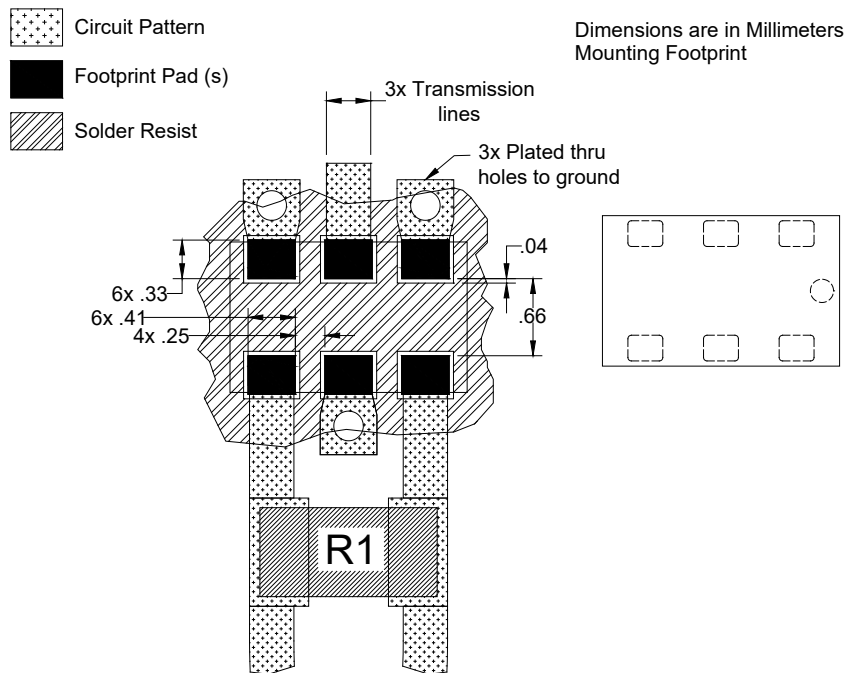

Packaging and Ordering Information

Parts are available in reel and are packaged per EIA 481-D. Parts are oriented in tape and reel as shown below. Minimum order quantities are 4000 per reel.

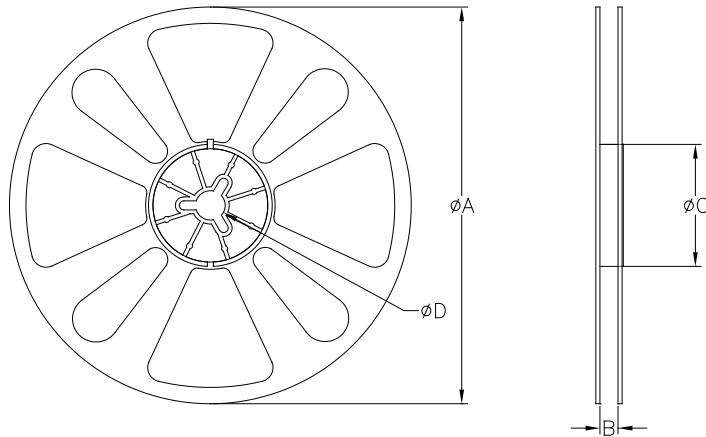
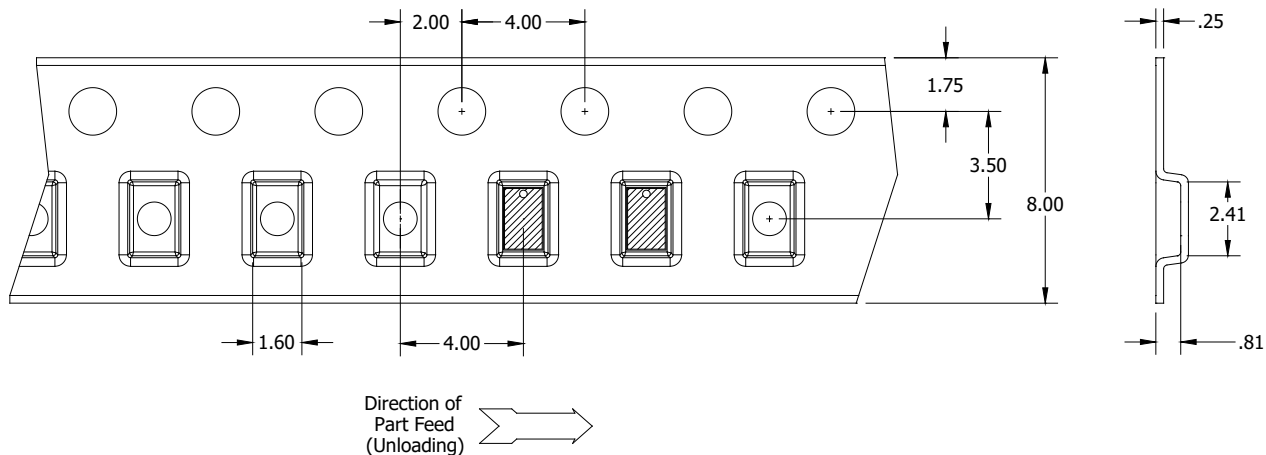

QUANTITY/REEL	REEL DIMENSIONS mm	
4000	ϕA	177.80
	B	8.00
	ϕC	50.80
	ϕD	13.00