

Xinger®

Ultra Low Profile 0603 Power Divider 50Ω to 50Ω

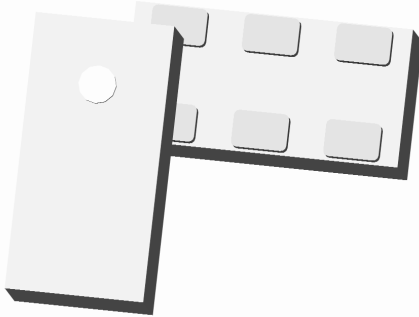

Description

The PD2635L5050S2HF is a low profile, sub-miniature Wilkinson power divider in an easy to use surface mount package. The PD2635L5050S2HF is ideal for high volume manufacturing and delivers higher performances than traditional printed and lumped element solutions. The PD2635L5050S2HF is matched to 50 Ω and has a height profile of 65mm, which is ideal for high-level integrations in the following markets: 5G, LTE. The PD2635L5050S2HF does not include the resistive element and therefore, requires an external resistor for operation. The PD2635L5050S2HF is available on tape and reel for high volume manufacturing pick and place.

Detailed Electrical Specifications: Specifications subject to change without notice.

| Features: | Parameter | Room (25°C) | | | | | | | | | | | | Unit |
|----------------------------|--------------------------|-------------|-----|------|------|-----|------|------|-----|------|------|-----|------|---------|
| | | Min | Typ | Max | Min | Typ | Max | Min | Typ | Max | Min | Typ | Max | |
| 2490-4000 MHz | Frequency | 2496 | | 2600 | 2600 | | 3500 | 3400 | | 3800 | 3800 | | 4000 | MHz |
| 0.65 mm Height Profile | Inout Port Impedance | | 50 | | | 50 | | | 50 | | | 50 | | Ω |
| 50Ω Input/50Ω Output | Putput Port Impedance | | | 50 | | 50 | | | 50 | | | 50 | | Ω |
| Low Insertion Loss | Return Loss | 13 | 16 | | 14 | 17 | | 14 | 17 | | 12 | 17 | | dB |
| Surface Mountable | Insertion Loss* | | 0.4 | 0.5 | | 0.3 | 0.5 | | 0.4 | 0.6 | | 0.4 | 0.7 | dB |
| Tape & Reel | Amplitude Balance | | 0 | 0.3 | | 0 | 0.3 | | 0 | 0.3 | | 0 | 0.4 | dB |
| Non-conductive Surface | Phase Balance | | 0.2 | 3 | | 0.2 | 3 | | 0.2 | 4 | | 0.2 | 4 | Degrees |
| RoHS Compliant | Isolation (Putput Ports) | 16 | 18 | | 15 | 20 | | 15 | 20 | | 14 | 20 | | dB |
| External Resistor Required | Power Handling@85°C | | | 2 | | | 2 | | | 2 | | | 2 | Watts |
| Halogen Free | Operating Temperature | -55 | | 140 | -55 | | 140 | -55 | | 140 | -55 | | 140 | °C |

* Insertion Loss stated at room temperature (Insertion Loss is approximately 0.1 dB higher at +85 °C)

Outline Drawing

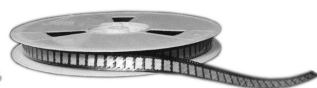
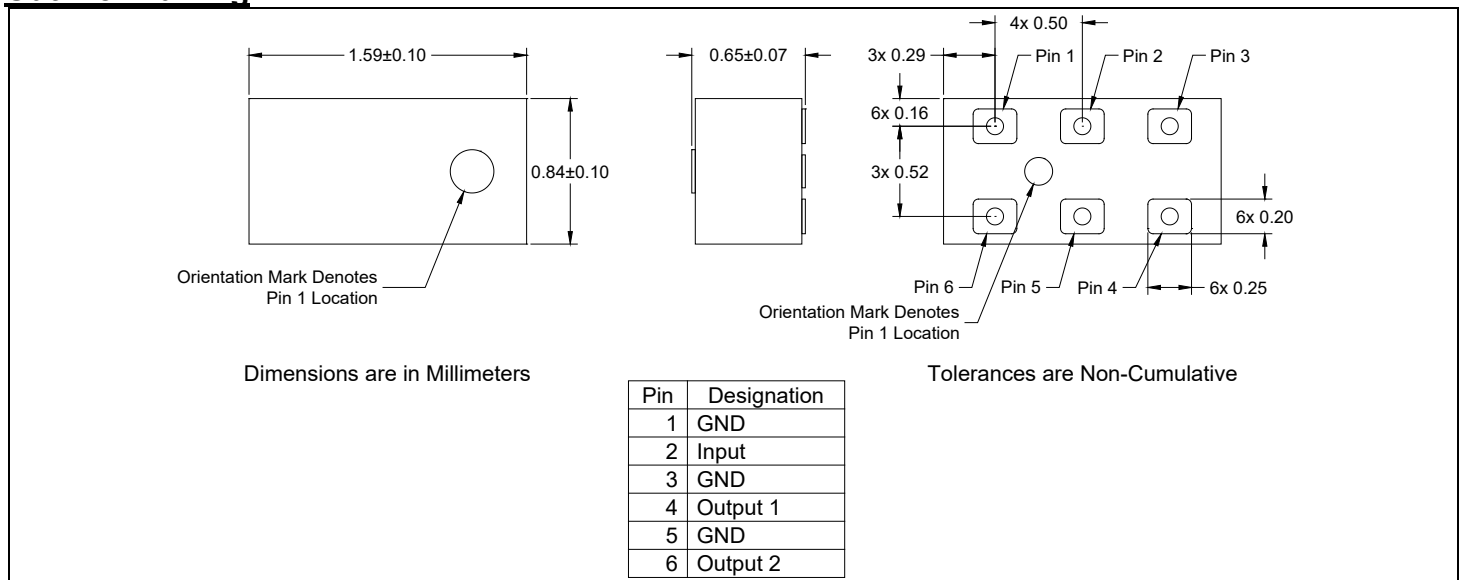

Typical Broadband Performance: 600 MHz to 7600 GHz

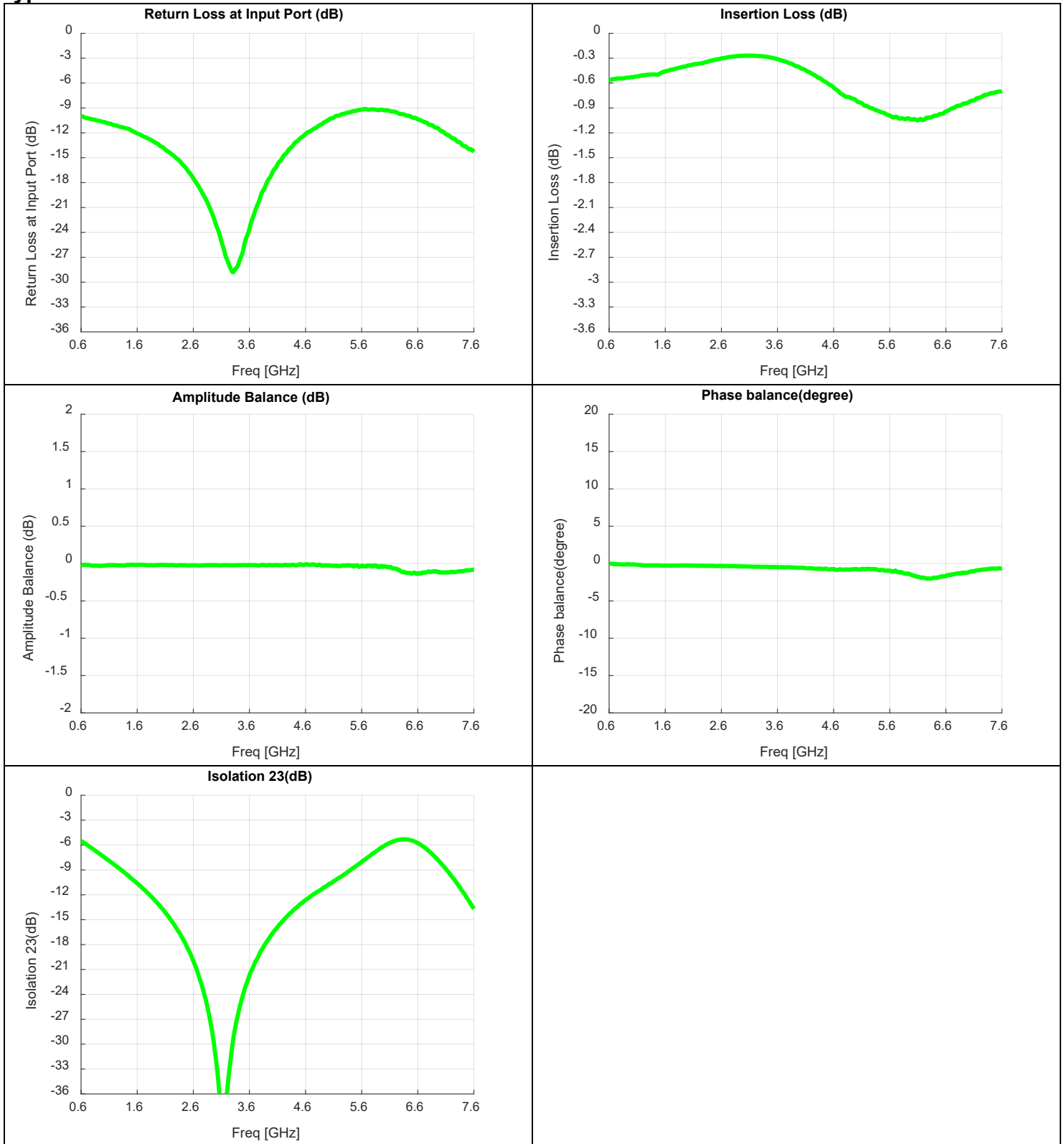

USA/Canada: (315) 233-5510
 Toll Free: (833) 389-6402
 Europe: +44 2392-232392
 Asia: +86 512 62749282

Available on Tape and Reel for Pick and Place Manufacturing.

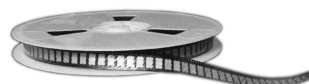

Anaren
 What'll we think of next?™

Typical Performance: 2300 MHz to 4100 MHz

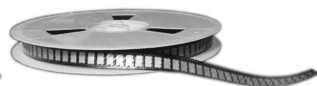
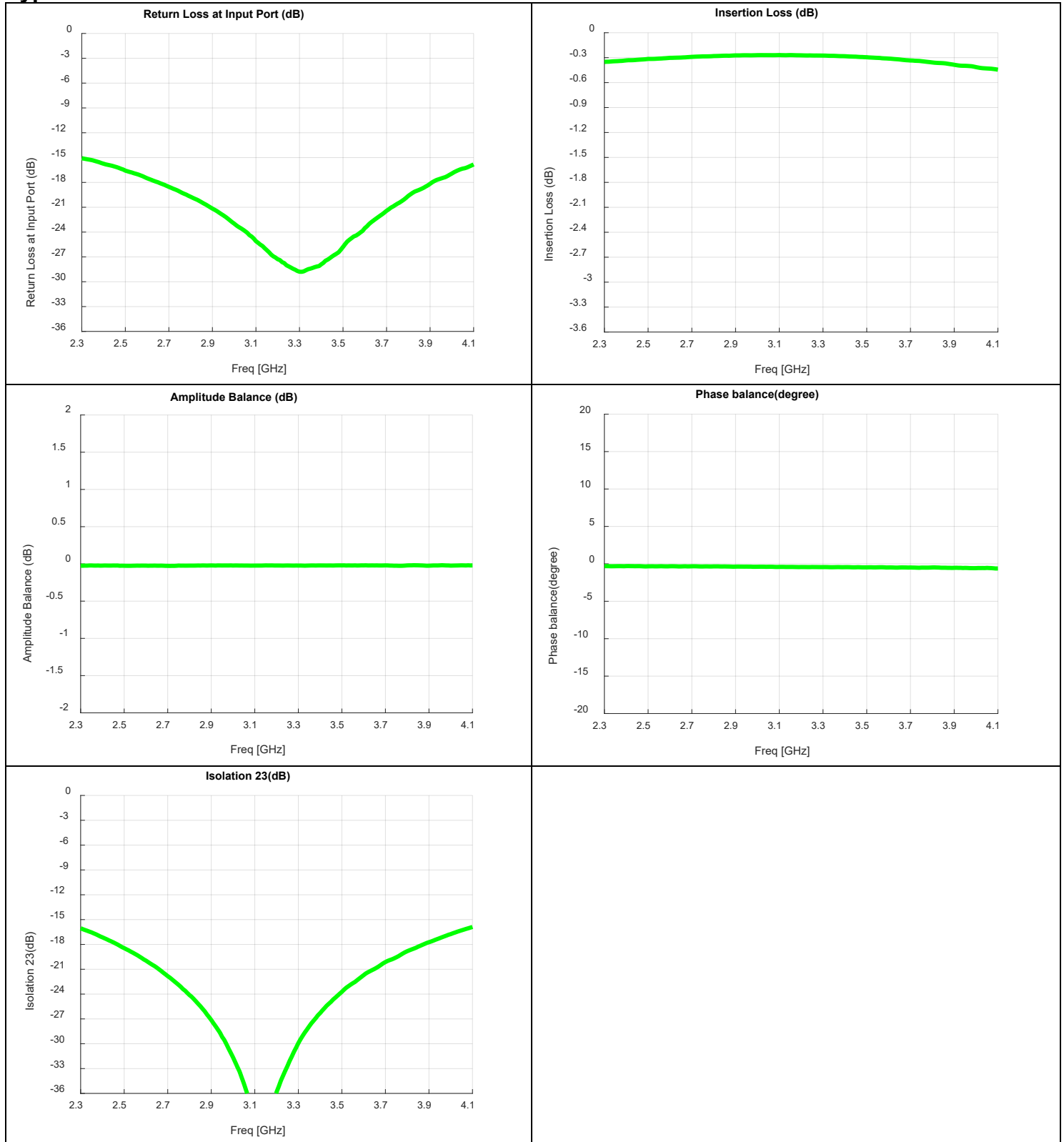

Mounting Configuration:

In order for Xinger surface mount components to work optimally, the proper impedance transmission lines must be used to connect to the RF ports. If this condition is not satisfied, insertion loss, Isolation and VSWR may not meet published specifications.

An example of the PCB footprint used in the testing of these parts is shown below. In specific designs, the transmission line widths need to be adjusted to the unique dielectric coefficients and thicknesses as well as varying pick and place equipment tolerances. In addition, since the PD2635L050S2HF is a Wilkinson power divider, an external 0603 100Ω resistor must be mounted in locations R1 as shown in the Figure below.

All of the Xinger components are constructed from organic PTFE based composites which possess excellent electrical and mechanical stability. Xinger components are compliant to a variety of ROHS and Green standards and ready for Pb-free soldering processes. Pads are Gold plated with a Nickel barrier.

In specific designs, the transmission line widths need to be adjusted to the unique dielectric coefficients and thicknesses as well as varying pick and place equipment tolerances.

Pad Footprint w/ 0402 Resistor Location

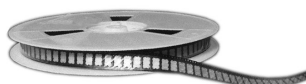
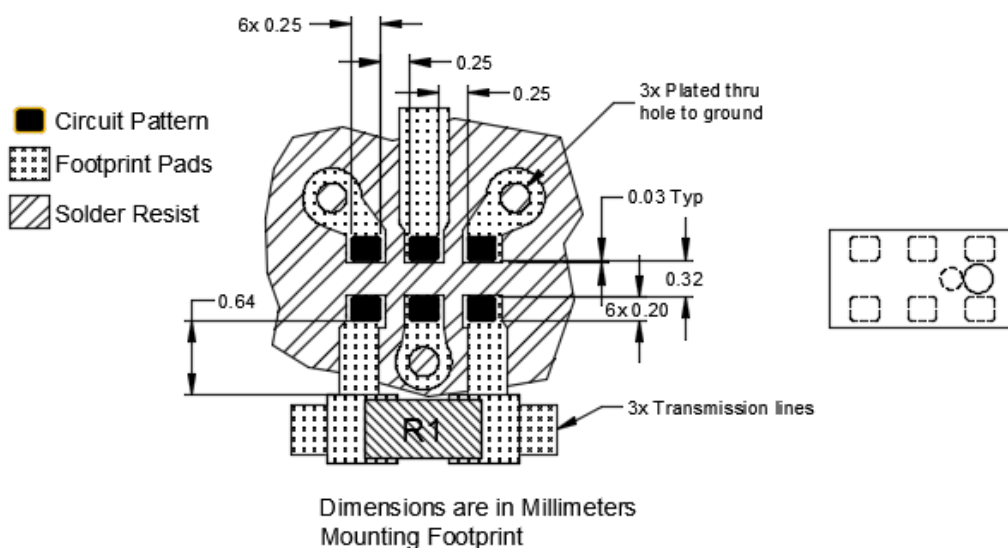

Packaging and Ordering Information

Parts are available in reel and are packaged per EIA 481-D. Parts are oriented in tape and reel as shown below. Minimum order quantities are 4000 per reel.

