

Xinger®

Ultra Low Profile 0805 Power Divider 50Ω to 50Ω

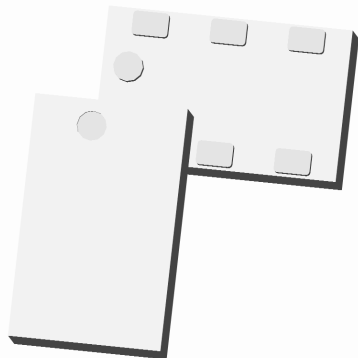

Description

The PD0922J5050D2HF is a low profile, sub-miniature Wilkinson power divider in an easy to use surface mount package and is ideal for high volume manufacturing while delivering higher performances than traditional printed and lumped element solutions. It has been designed for the following markets: DVB-S, GSM, DCS, PCS, CDMA and GPS.

The PD0922J5050D2HF is matched to 50 Ω and has a height profile of 0.8 mm which is ideal for high level integrations. A 2 section Wilkinson design results in increased isolation performance. Two external resistors are required for operation. Components are available on tape and reel for high volume manufacturing pick and place.

Detailed Electrical Specifications: Specifications subject to change without notice.

Features:	Parameter	ROOM (25°C)			Unit
		Min.	Typ.	Max	
• 950 – 2150 MHz	Frequency	950		2150	MHz
• 12dB Isolation (output ports)	Input Port Impedance		50		Ω
• Good Return Loss	Output Port Impedance		50		Ω
• 0.8mm Height Profile	Return Loss	9.3	11		dB
• 50Ω Outputs/Inputs	Insertion Loss*		0.7	0.8	dB
• External resistors required	Amplitude Balance		0.1	0.5	dB
• Low Insertion Loss	Phase Balance		1	3	Degrees
• Surface Mountable	Isolation (Output Ports)	10.5	12		dB
• Tape & Reel	Power Handling @85°C			2	Watts
• Non-conductive Surface	@105°C			1.2	Watts
• RoHS Compliant	Operating Temperature	-55		+140	°C
• Halogen Free					

* Insertion Loss stated at room temperature (Insertion Loss is approximately 0.1 dB higher at +85 °C)

Outline Drawing

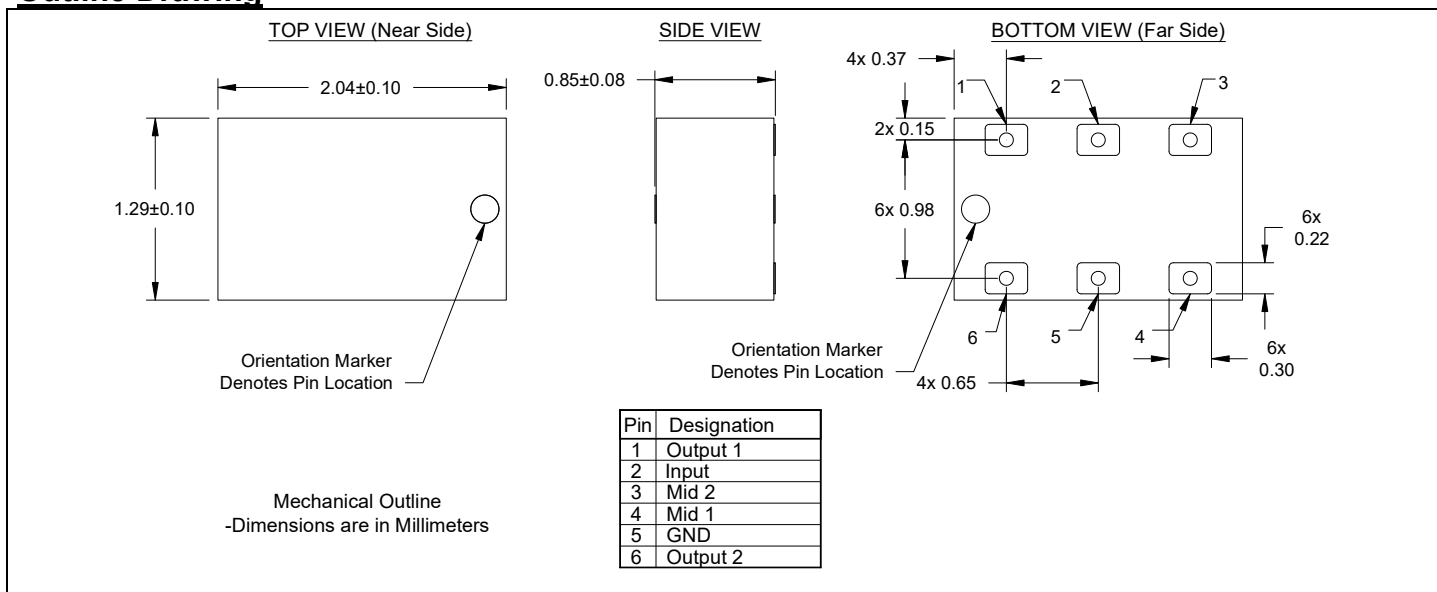

Typical Broadband Performance: 500 MHz. to 8.5 GHz.

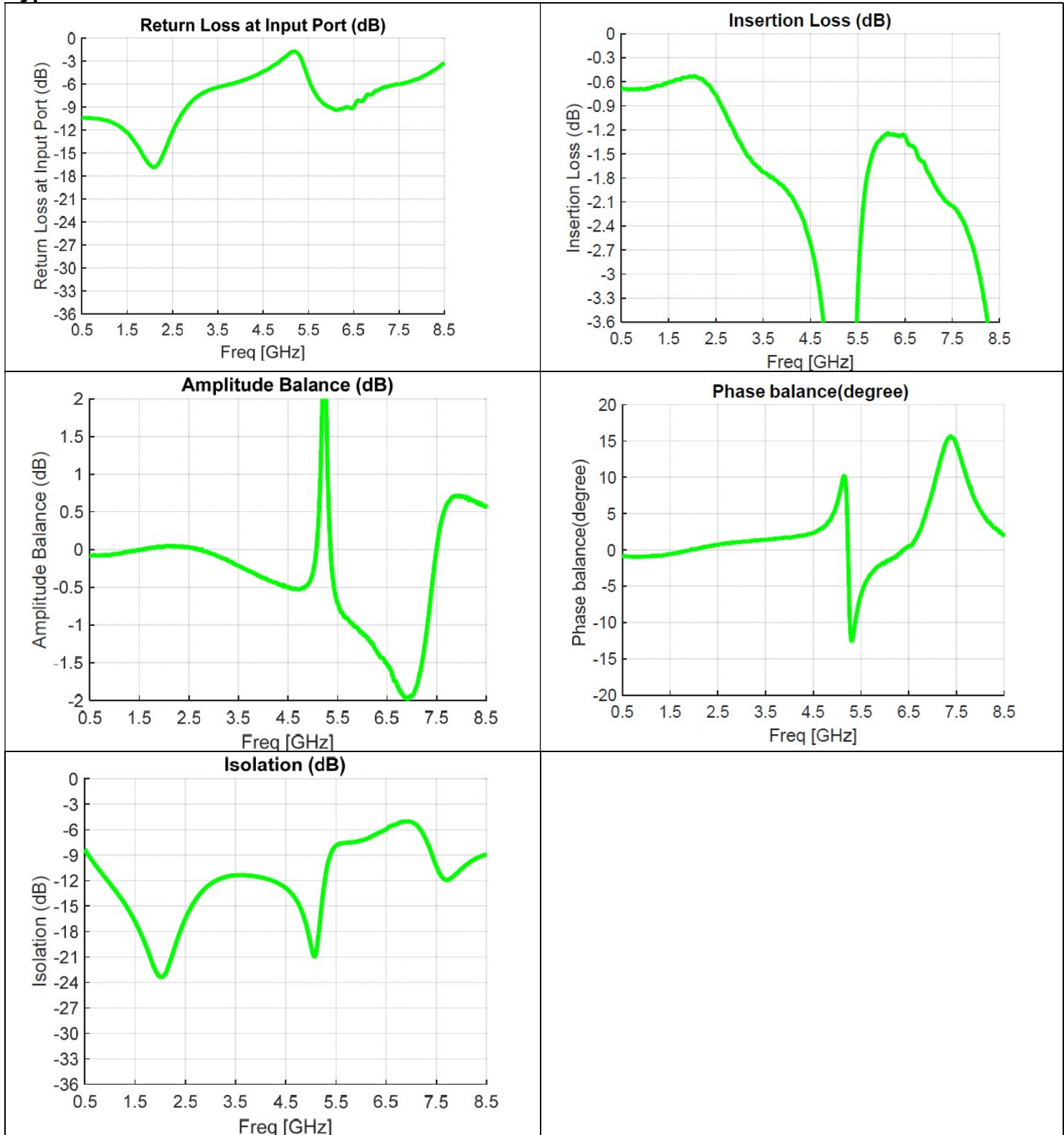

Typical Performance: 600 MHz. to 2600 MHz.

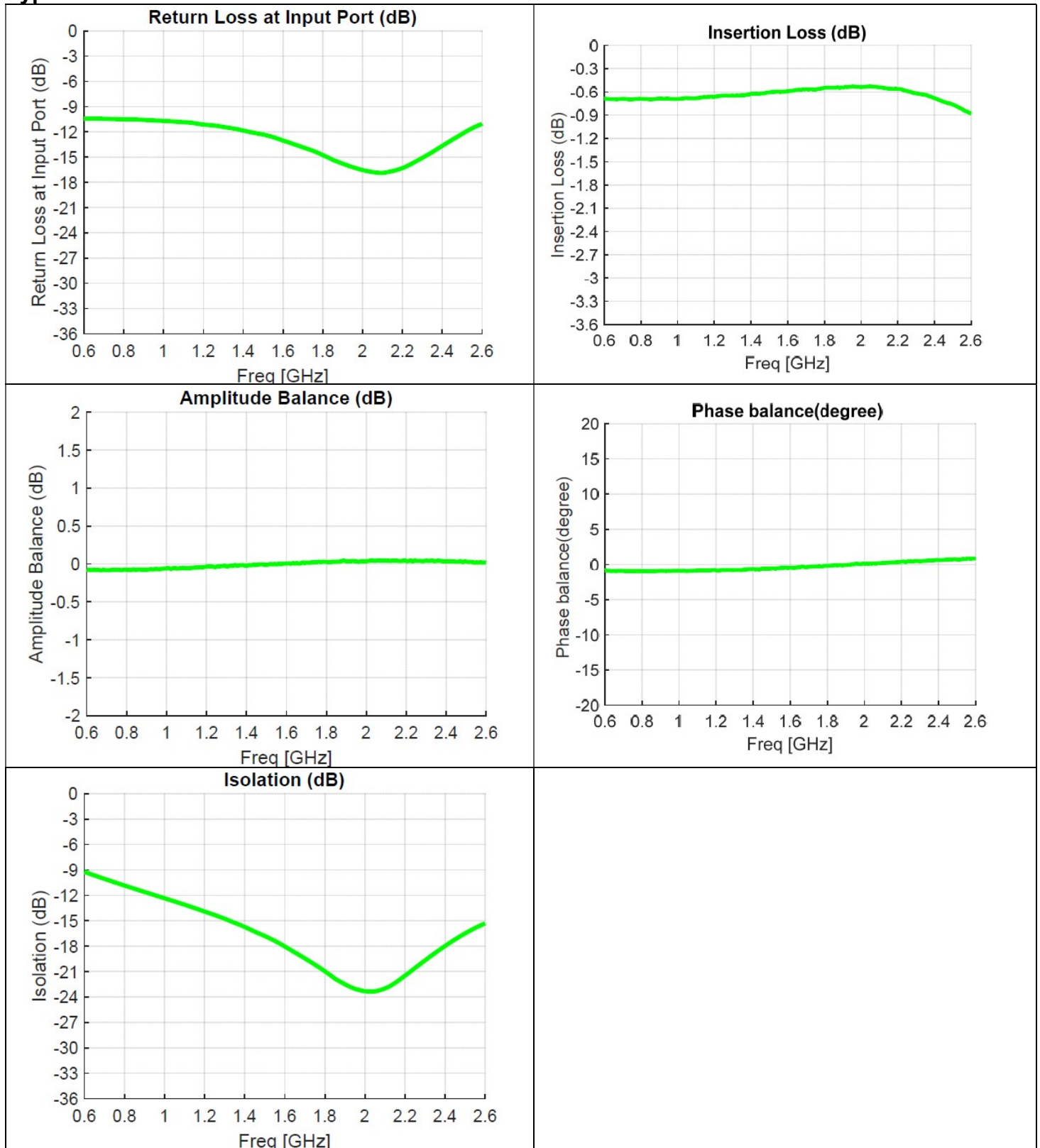



Mounting Configuration:

In order for Xinger surface mount components to work optimally, the proper impedance transmission lines must be used to connect to the RF ports. If this condition is not satisfied, insertion loss, Isolation and VSWR may not meet published specifications.

All of the Xinger components are constructed from organic PTFE based composites which possess excellent electrical and mechanical stability. Xinger components are compliant to a variety of ROHS and Green standards and ready for Pb-free soldering processes. Pads are Gold plated with a Nickel barrier.

An example of the PCB footprint used in the testing of these parts is shown below. In specific designs, the transmission line widths need to be adjusted to the unique dielectric coefficients and thicknesses as well as varying pick and place equipment tolerances. In addition, since the PD0922J5050D2HF is a Wilkinson power divider, external 0402 100Ω and 200Ω resistors must be mounted in locations R1 and R2 respectively, as shown in the Figure below.

Pad Footprint w/ Wilkinson 0402 Resistor Locations

-  Circuit Pattern
-  Footprint Pad (s)
-  Solder Resist

Dimensions are in Millimeters
Mounting Footprint

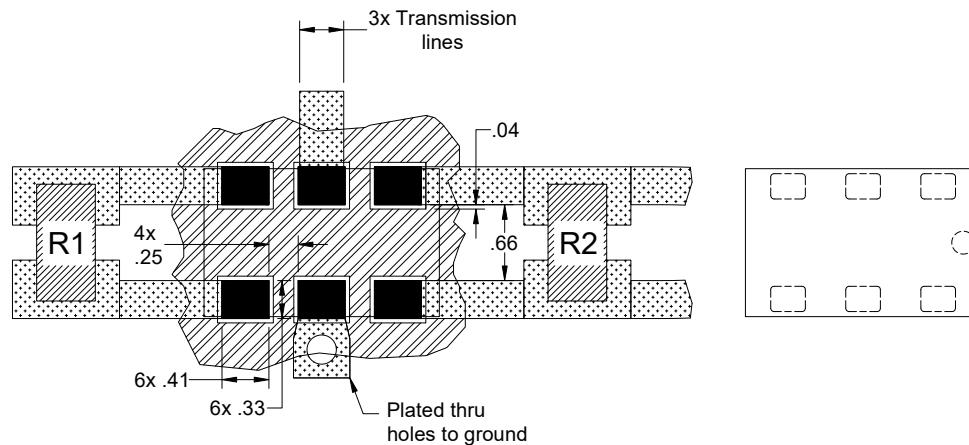

Packaging and Ordering Information

Parts are available in reel and are packaged per EIA 481-D. Parts are oriented in tape and reel as shown below. Minimum order quantities are 4000 per reel.

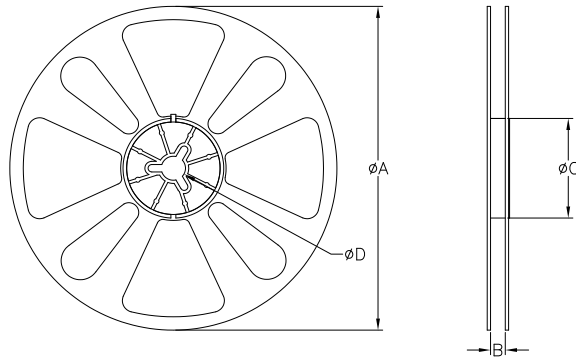
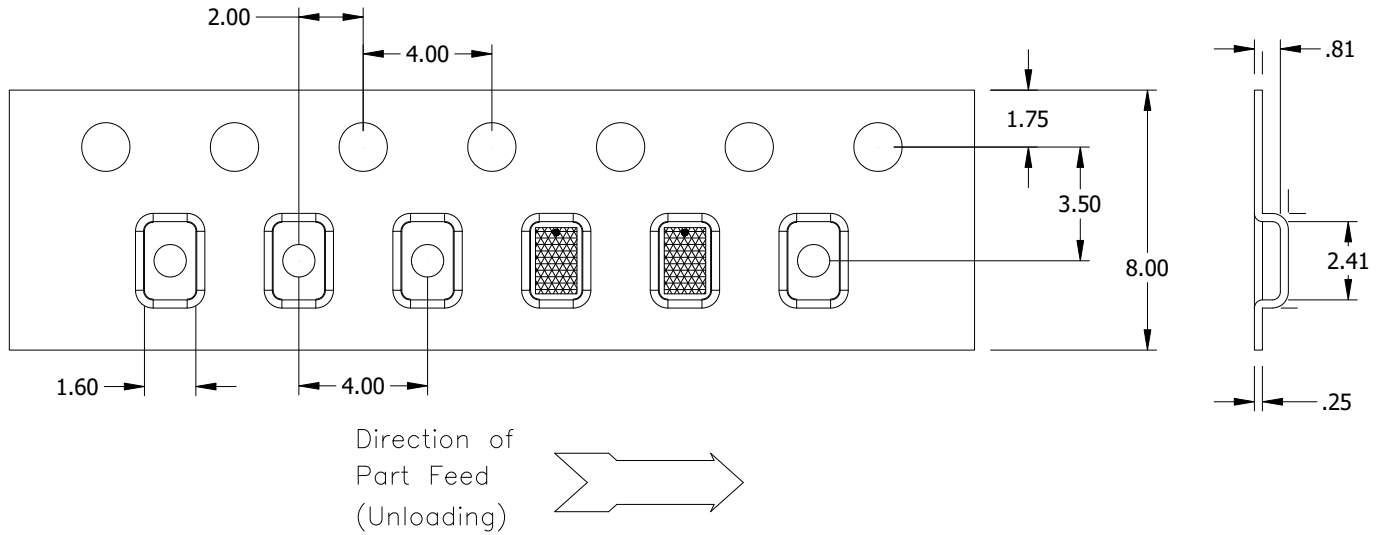

TABLE 1		
QUANTITY/REEL	REEL DIMENSIONS mm	
4000	ϕA	177.80
	B	8.00
	ϕC	50.80
	ϕD	13.00