

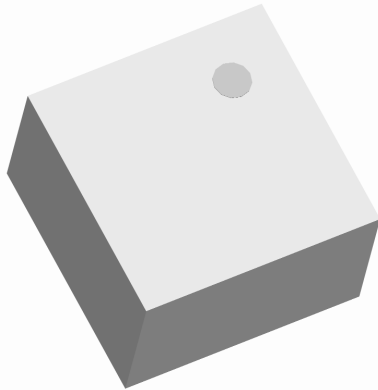

Ultra Low Profile Halogen Free 0404 Balun 50Ω to 100Ω Balanced



Description

The BD0810N50100AHF is one of the world's smallest and highest performance, halogen free, low profile sub-miniature unbalanced to balanced transformer targeted at the 900MHz ISM bands as well as the low band WCDMA / GSM markets and designed specifically for differential inputs and output locations on modern chipsets in an easy to use surface mount package. The BD0810N50100AHF is ideal for high volume manufacturing and delivers higher performance than traditional ceramic baluns. The BD0810N50100AHF has an unbalanced port impedance of 50Ω and 100Ω balanced port impedance. The balanced ports have equal amplitude (-3dB) with 180 degree phase differential. The BD0810N50100AHF is available on tape and reel for pick and place high volume manufacturing.

IMPORTANT: This balun must be used with a capacitor across the differential ports as shown on Page 4 to optimize the performance.

Detailed Electrical Specifications: Specifications subject to change without notice.

Features:

- 800 – 1000 MHz
- 0.57 mm Height Profile
- 50 Ohm to 2 x 50 Ohm
- Low Insertion Loss
- Class leading CMRR
- Targeted for WCDMA, GSM, PMR, ULPR & All ISM Protocols
- Surface Mountable
- Tape & Reel
- Non-conductive Top Surface
- RoHS Compliant
- Halogen Free

Parameter	ROOM (25°C)			Unit
	Min.	Typ.	Max	
Frequency	800		1000	MHz
Unbalanced Port Impedance		50		Ω
Balanced Port Impedance		100		Ω
Return Loss	18	24		dB
Insertion Loss*		1.0	1.2	dB
Amplitude Balance		1.0	1.4	dB
Phase Balance		5	9	Degrees
CMRR		24		dB
Power Handling			0.75	Watts
Operating Temperature	-55		+85	°C

* Insertion Loss stated at room temperature. Values above are for the case with shunt capacitor across differential lines.

Outline Drawing

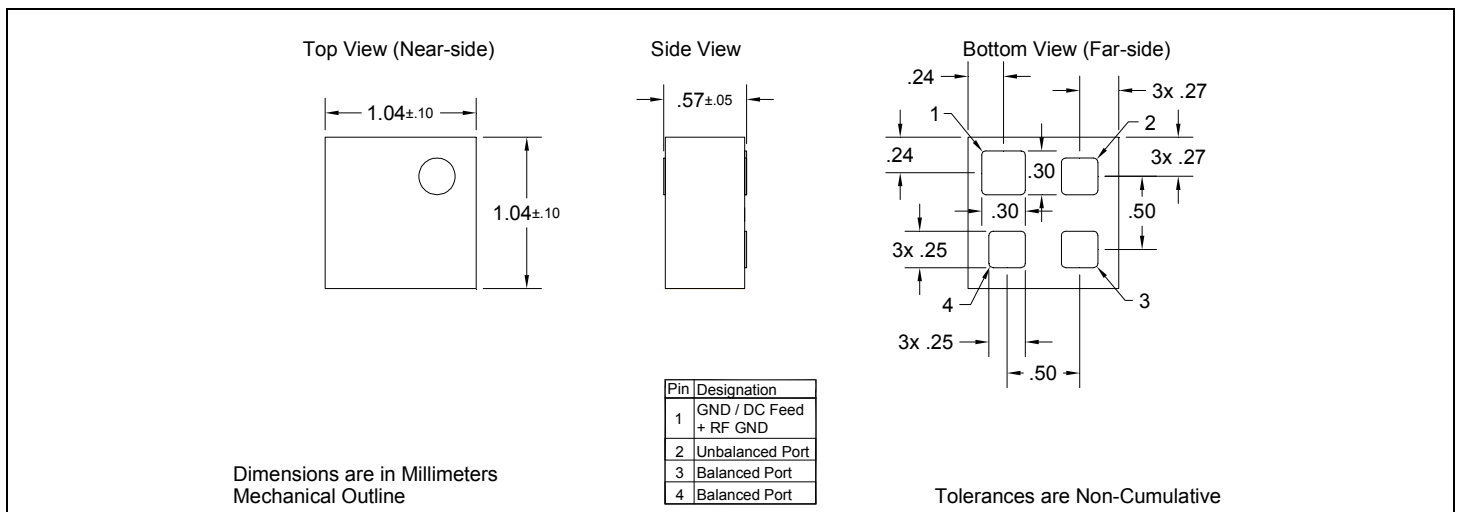

Typical Performance: 700 MHz. to 1100 MHz.

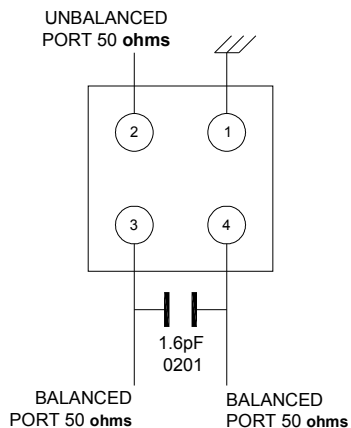

Schematic of BD0810N50100AHF with 1.6pF cross the balanced ports

Return Loss - Input

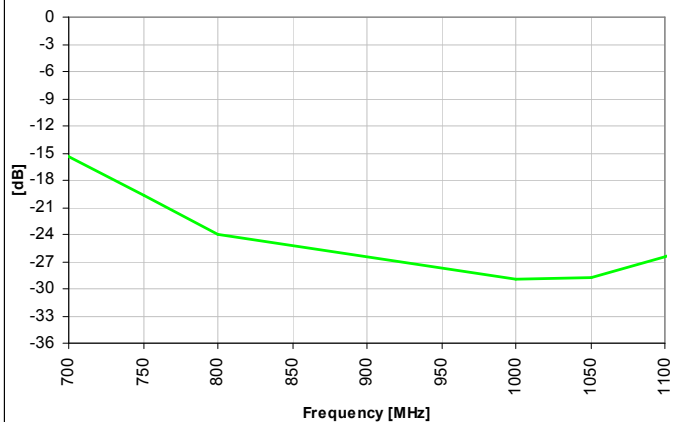

Insertion Loss

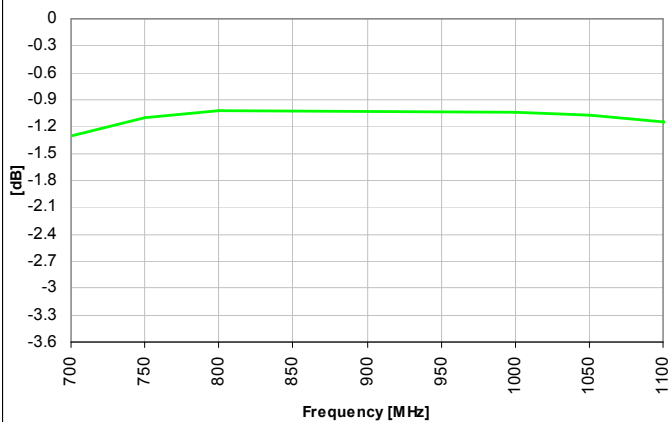

Amplitude Balance

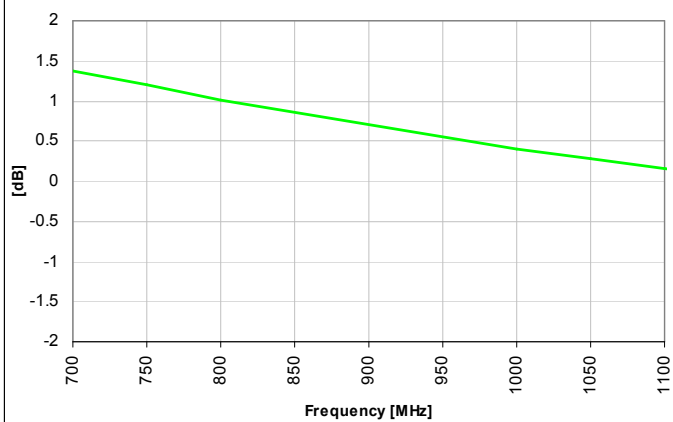

Phase Balance

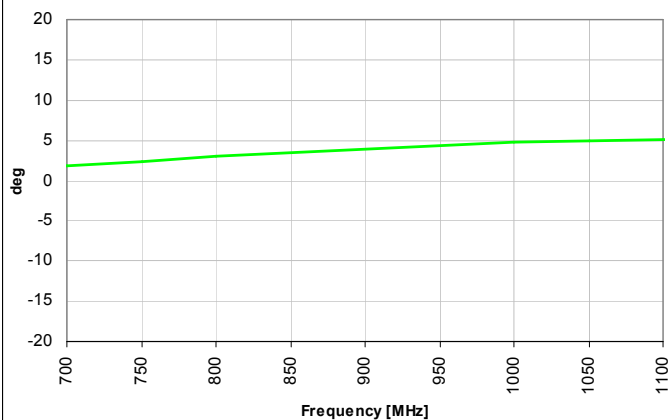

CMRR

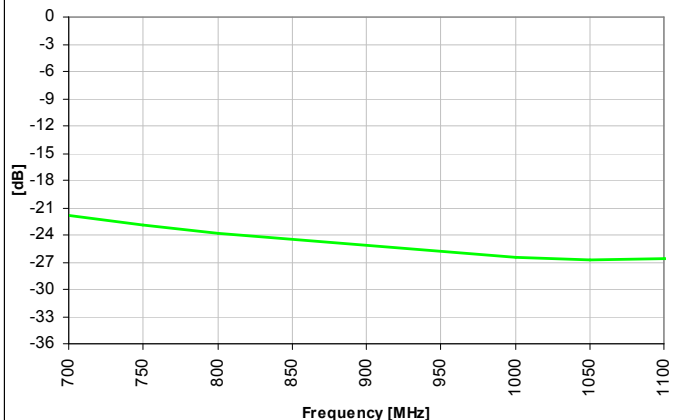

Wide Band Performance: 500 MHz. to 8500 MHz.

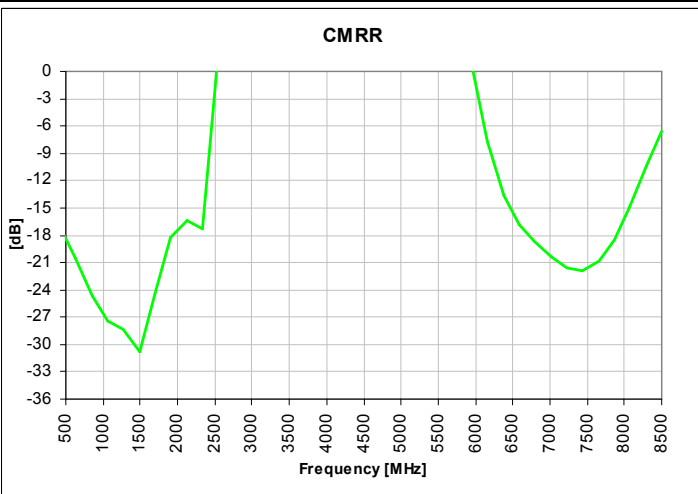
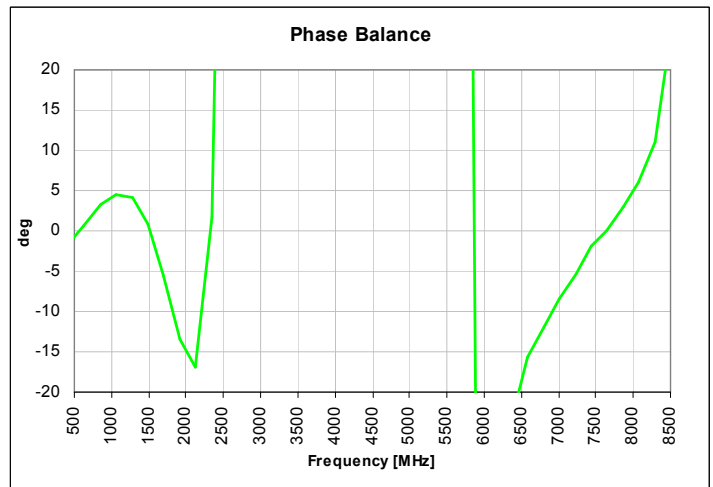
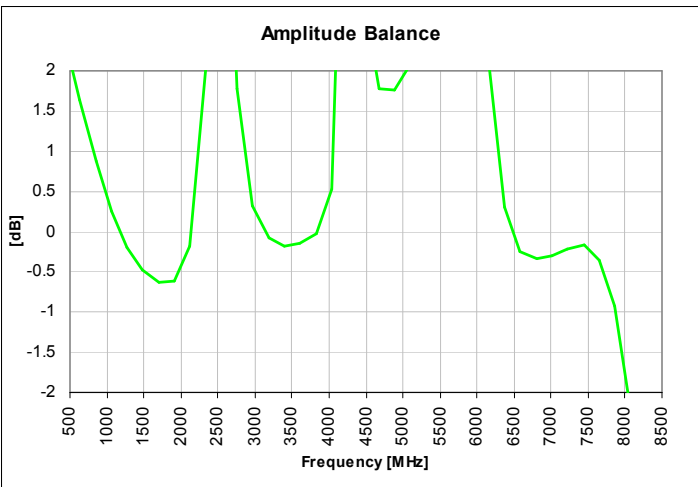
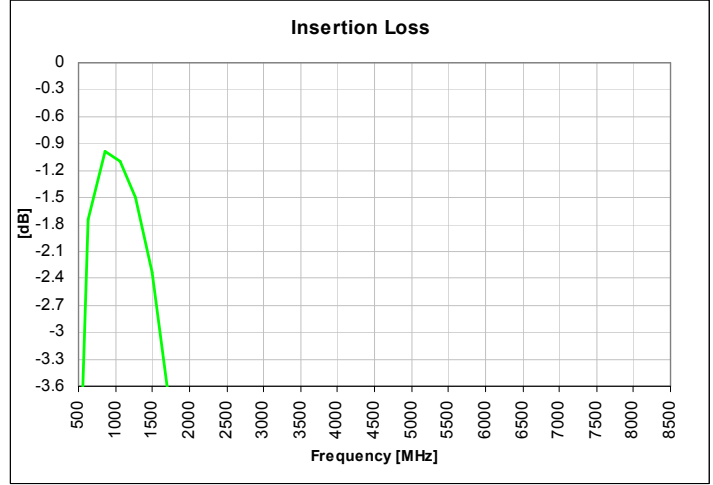
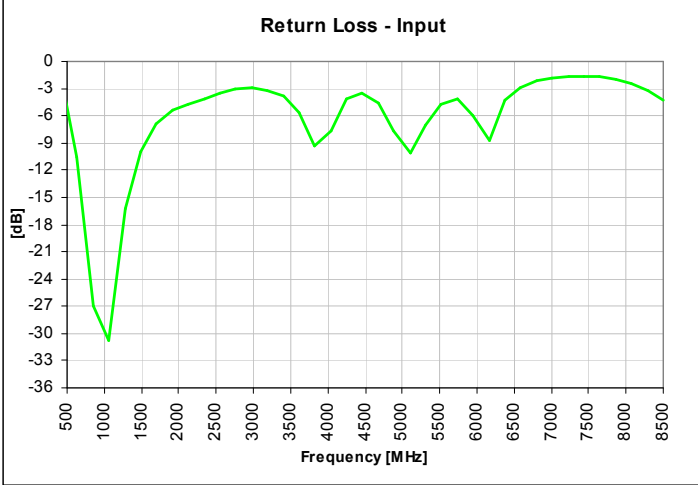

Mounting Configuration:

In order for Xinger surface mount components to work optimally, the proper impedance transmission lines must be used to connect to the RF ports. If this condition is not satisfied, insertion loss, Isolation and VSWR may not meet published specifications.

All of the Xinger components are constructed from organic PTFE based composites which possess excellent electrical and mechanical stability. Xinger components are compliant to a variety of ROHS and Green standards and ready for Pb-free soldering processes. Pads are Gold plated with a Nickel barrier.

An example of the PCB footprint used in the testing of these parts is shown below. **Note that the BD0810N50100AHF requires a 0201 size 1.6 pF capacitor across the differential (balanced) lines as shown in the diagram below for the specific case of a 5 mil thick Polyamide substrate.** This value may need to be adjusted slightly for different substrate thicknesses and dielectric constants.

For specific designs, the transmission line widths need to be adjusted to the unique dielectric coefficients and thicknesses as well as varying pick and place equipment tolerances.

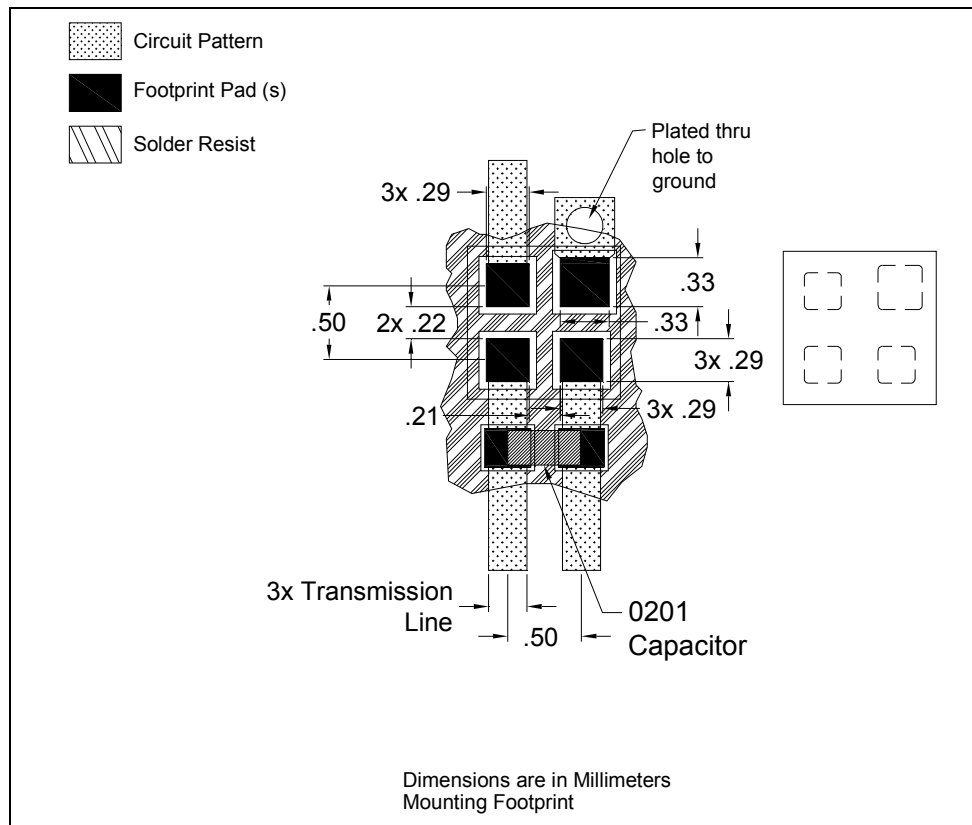

Packaging and Ordering Information

Parts are available in reel and are packaged per EIA 481-2. Parts are oriented in tape and reel as shown below. Minimum order quantities are 4000 per reel. See Model Numbers below for further ordering information.

