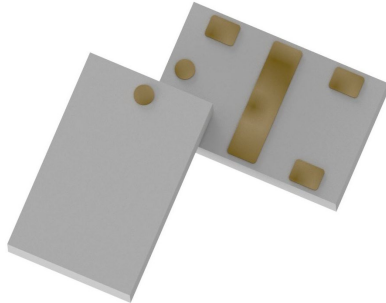


# Xinger® IV



## Ultra Low Profile 0805 3dB Hybrid Coupler

### Description

The X4C35J1-03G is a low profile, high performance 3dB hybrid coupler in a new easy to use, manufacturing friendly surface mount package. It is designed for 5G applications. The X4C35J1-03G is available on tape and reel for pick and place high volume manufacturing.

All of the Xinger components are constructed from ceramic filled PTFE composites, which possess excellent electrical and mechanical stability. All parts have been subjected to rigorous qualification testing and units are 100% RF tested. Produced in an ENIG final finish.

### Features:

- 3100-4200 MHz
- 5G Applications
- Very Low Loss
- Tight Amplitude Balance
- High Isolation
- Production Friendly
- Tape and Reel

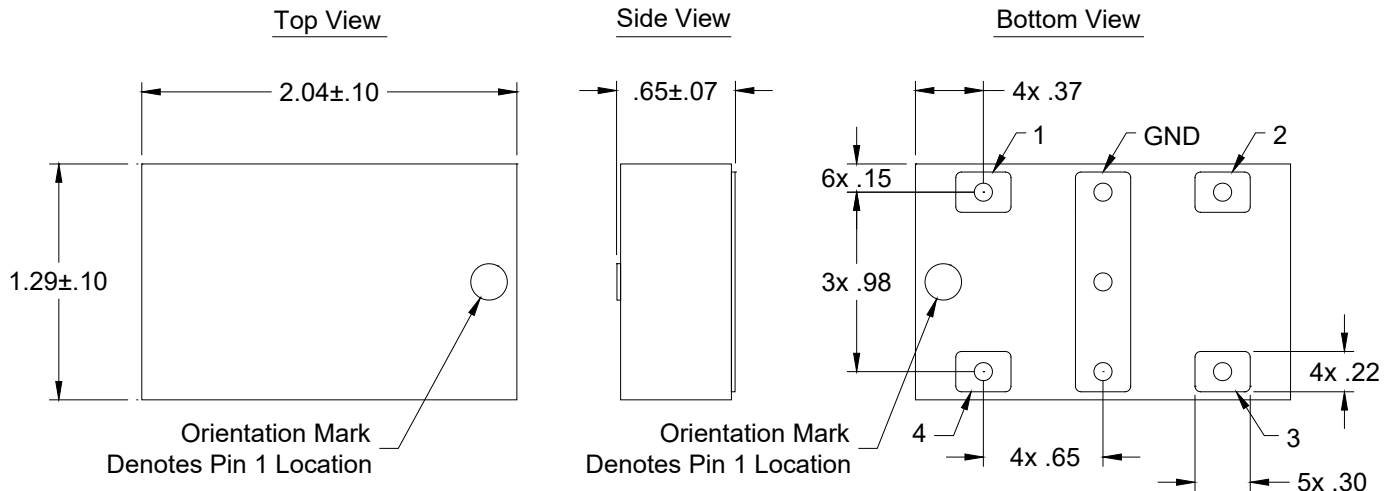
### Electrical Specifications \*\*

Frequency	Isolation	Insertion Loss	Return Loss	Amplitude Balance
<i>MHz</i>	<i>dB Min</i>	<i>dB Max</i>	<i>dB Min</i>	<i>dB Max</i>
3100-4200	20	0.5	20	± 0.5
	Phase	Group Delay	Power	Operating Temp.
	<i>Degrees</i>	<i>Max nS</i>	<i>Avg. CW Watts @105°C</i>	<i>°C</i>
	90 ± 4	0.07	5	-55 to +140

\*\*Specification based on performance of unit properly installed on Anaren Test Board with small signal applied.

\*Specifications subject to change without notice. Refer to parameter definitions for details.

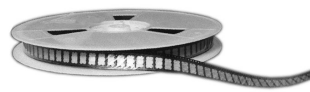
### Mechanical Outline



-Dimensions are in Millimeters  
-Tolerances are Non-Cumulative

USA/Canada: (315) 233-5510  
Toll Free: (833) 389-6402  
Europe: +44 2392-232392  
Asia: +86 512 62749282

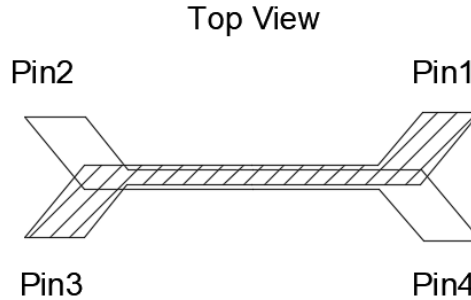
Available on Tape and Reel for Pick and Place Manufacturing.



**Anaren®**  
What'll we think of next?®

## Hybrid Coupler Pin Configuration

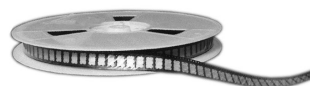
The X4C35J1-03G has an orientation marker to denote Pin 1. Once port one has been identified the other ports are known automatically. Please see the chart below for clarification:



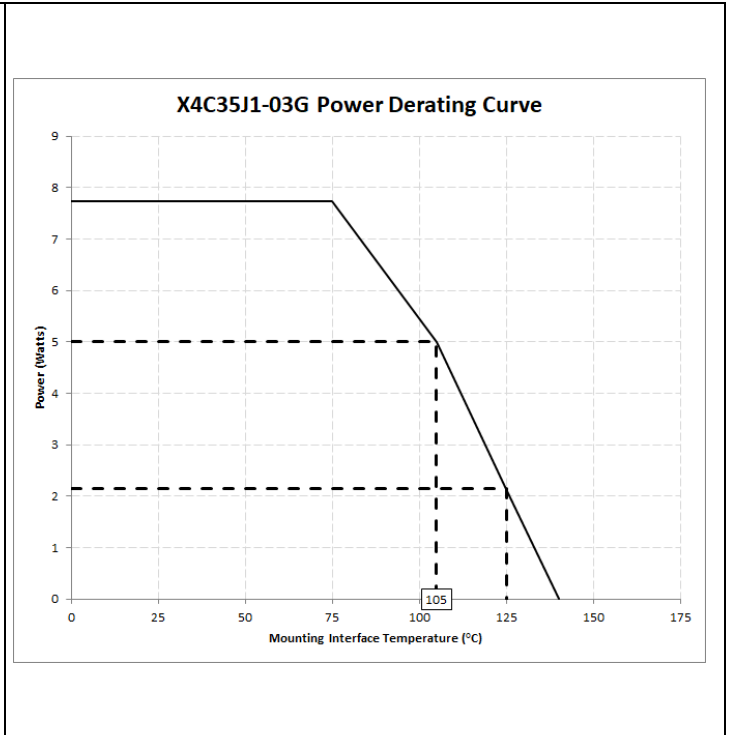
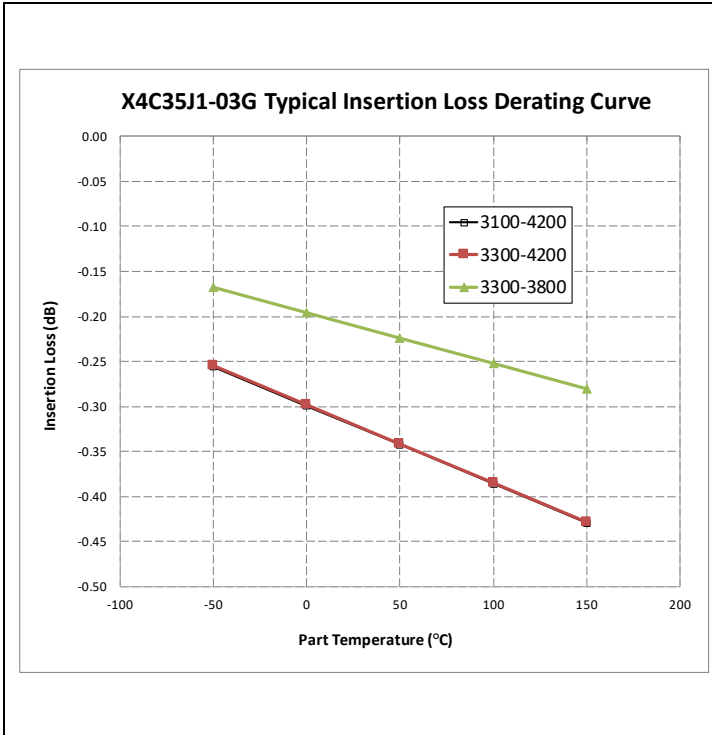
**3dB Coupler Pin Configuration**

Configuration	Pin 1	Pin 2	Pin 3	Pin 4
<b>Splitter</b>	Input	Isolated	-3dB $\angle \theta - 90$	-3dB $\angle \theta$
<b>Splitter</b>	Isolated	Input	-3dB $\angle \theta$	-3dB $\angle \theta - 90$
<b>Splitter</b>	-3dB $\angle \theta - 90$	-3dB $\angle \theta$	Input	Isolated
<b>Splitter</b>	-3dB $\angle \theta$	-3dB $\angle \theta - 90$	Isolated	Input
<b>*Combiner</b>	$A \angle \theta - 90$	$A \angle \theta$	Isolated	Output
<b>*Combiner</b>	$A \angle \theta$	$A \angle \theta - 90$	Output	Isolated
<b>*Combiner</b>	Isolated	Output	$A \angle \theta - 90$	$A \angle \theta$
<b>*Combiner</b>	Output	Isolated	$A \angle \theta$	$A \angle \theta - 90$

Note: The direct port has a DC connection to the input port and the coupled port has a DC connection to the isolated port. For optimum IL and power handling performance, use Pin 1 or Pin 3 as inputs.



### Insertion Loss and Power Derating Curves



#### Insertion Loss Derating:

The insertion loss, at a given frequency, of a group of couplers is measured at 25°C and then averaged. The measurements are performed under small signal conditions (i.e. using a Vector Network Analyzer). The process is repeated at -55°C, 105°C and 140°C. A best-fit line for the measured data is computed and then plotted from -55°C to 140°C.

#### Power Derating:

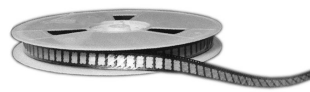
The power handling and corresponding power derating plots are a function of the thermal resistance, mounting surface temperature (base plate temperature), maximum continuous operating temperature of the coupler, and the thermal insertion loss. The thermal insertion loss is defined in the Power Handling section of the data sheet.

As the mounting interface temperature approaches the maximum continuous operating temperature, the power handling decreases to zero.

If mounting temperature is greater than 105°C, Xinger coupler will perform reliably as long as the input power is derated to the curve above.

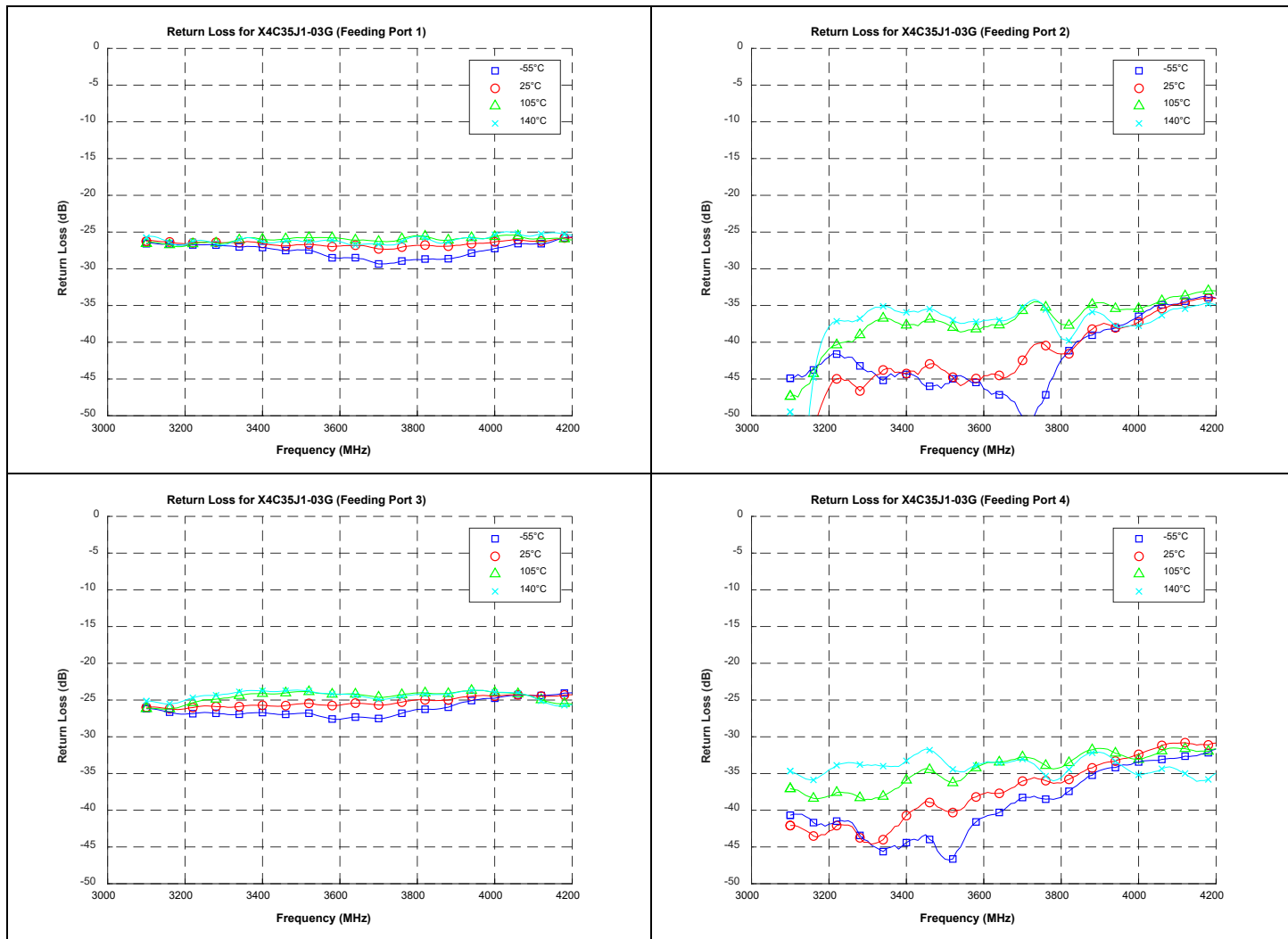
USA/Canada: (315) 233-5510  
 Toll Free: (833) 389-6402  
 Europe: +44 2392-232392  
 Asia: +86 512 62749282

Available on Tape and Reel for Pick and Place Manufacturing.



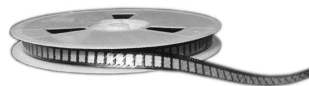
**Anaren®**  
 What'll we think of next?®

## Typical Performance: 3100 MHz to 4200 MHz (Configuration 1)



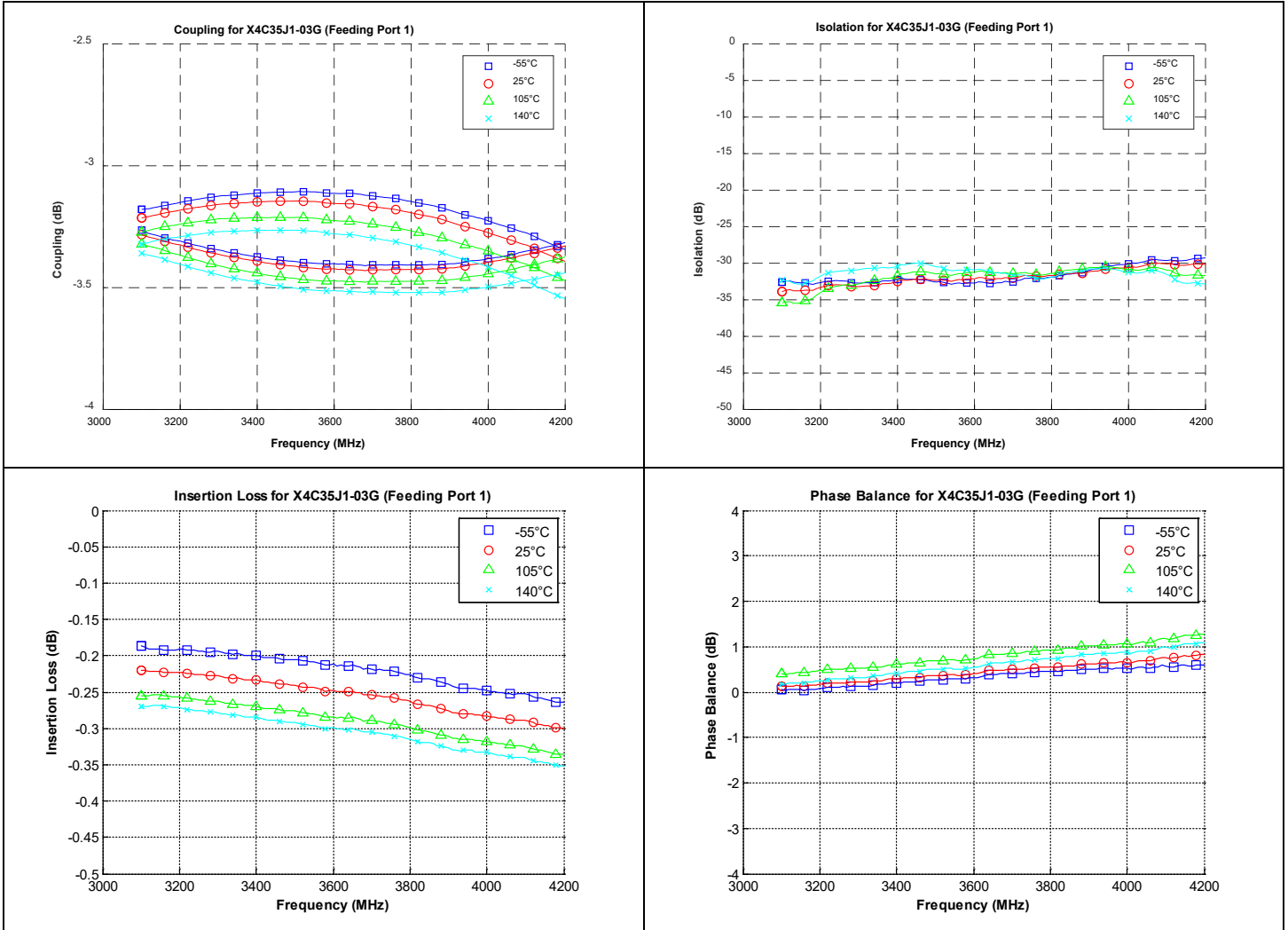
USA/Canada: (315) 233-5510  
 Toll Free: (833) 389-6402  
 Europe: +44 2392-232392  
 Asia: +86 512 62749282

Available on Tape and Reel for Pick and Place Manufacturing.



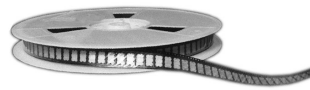
**Anaren®**  
 What'll we think of next?®

### Typical Performance: 3100 MHz to 4200 MHz (Configuration 1)



USA/Canada: (315) 233-5510  
 Toll Free: (833) 389-6402  
 Europe: +44 2392-232392  
 Asia: +86 512 62749282

Available on Tape and Reel for Pick and Place Manufacturing.



**Anaren®**  
 What'll we think of next?®

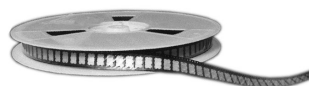
## Definition of Measured Specifications

Parameter	Definition	Mathematical Representation
<b>VSWR (Voltage Standing Wave Ratio)</b>	The impedance match of the coupler to a 50Ω system. A VSWR of 1:1 is optimal.	$VSWR = \frac{V_{max}}{V_{min}}$ <p>Vmax = voltage maxima of a standing wave Vmin = voltage minima of a standing wave</p>
<b>Return Loss</b>	The impedance match of the coupler to a 50Ω system. Return Loss is an alternate means to express VSWR.	$\text{Return Loss (dB)} = 20 \log \frac{VSWR + 1}{VSWR - 1}$
<b>Insertion Loss</b>	The input power divided by the sum of the power at the two output ports.	$10 \log \frac{P_{in}}{P_{cpl} + P_{direct}}$
<b>Isolation</b>	The input power divided by the power at the isolated port.	$\text{Isolation (dB)} = 10 \log \frac{P_{in}}{P_{iso}}$
<b>Amplitude Balance</b>	The power at each output divided by the average power of the two outputs.	$10 \log \left( \frac{P_{cpl}}{P_{cpl} + P_{direct}} \right) \text{ and } 10 \log \left( \frac{P_{direct}}{P_{cpl} + P_{direct}} \right)$
<b>Phase Balance</b>	The difference in phase angle between the two output ports.	Phase at coupled port – Phase at direct port
<b>Frequency Sensitivity</b>	The decibel difference between the maximum in band coupling value and the mean coupling, and the decibel difference between the minimum in band coupling value and the mean coupling.	<p>Max Coupling (dB) – Mean Coupling (dB) and Min Coupling (dB) – Mean Coupling (dB)</p>
<b>Group Delay (GD-C)</b>	Group delay is average of group delay's from input port to the coupled port	Average (GD-C)
<b>Group Delay (GD-DC)</b>	Group delay is average of group delay's from input port to the direct port	Average (GD-DC)

\*100% RF test is performed per spec definition for pin configuration 1 and 2.

USA/Canada: (315) 233-5510  
Toll Free: (833) 389-6402  
Europe: +44 2392-232392  
Asia: +86 512 62749282

Available on Tape and Reel for Pick and Place Manufacturing.



**Anaren®**  
What'll we think of next?®

### Notes on RF Testing and Circuit Layout:

The effects of the test fixture on the measured data must be minimized in order to accurately determine the performance of the device under test. If the line impedance is anything other than 50Ω and/or there is a discontinuity at the microstrip to SMA interface, there will be errors in the data for the device under test. The test environment can never be “perfect”, but the procedure used to build and evaluate the test boards (outlined below) demonstrates an attempt to minimize the errors associated with testing these devices. The lower the signal level that is being measured, the more impact the fixture errors will have on the data. Parameters such as Return Loss and Isolation/Directivity, which are specified as low as 27dB and typically measure at much lower levels, will present the greatest measurement challenge.

**Note:** The S-parameter files that are available on the anaren.com website include data for frequencies that are outside of the specified band.

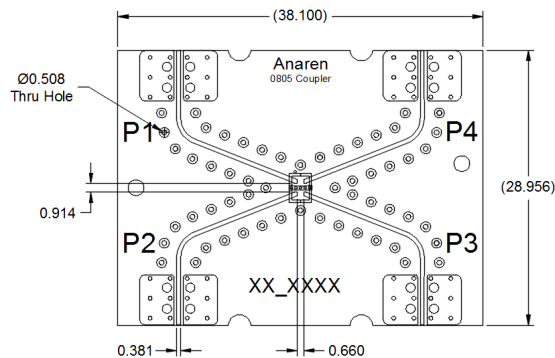
### Circuit Board Layout

The dimensions for the Anaren test board are shown below. The test board is printed on Rogers RO4003 material that is 0.008” thick. Consider the case when a different material is used. First, the pad size must remain the same to accommodate the part. But, if the material thickness or dielectric constant (or both) changes, the reactance at the interface to the coupler will also change. Second, the linewidth required for 50Ω will be different and this will introduce a step in the line at the pad where the coupler interfaces with the printed microstrip trace. Both of these conditions will affect the performance of the part. **To achieve the specified performance, serious attention must be given to the design and layout of the circuit environment in which this component will be used.**

If a different circuit board material is used, an attempt should be made to achieve the same interface pad reactance that is present on the Anaren RO4003 test board. When thinner circuit board material is used, the ground plane will be closer to the pad yielding more capacitance for the same size interface pad. The same is true if the dielectric constant of the circuit board material is higher than is used on the Anaren test board. In both of these cases, narrowing the line before the interface pad will introduce a series inductance, which, when properly tuned, will compensate for the extra capacitive reactance. If a thicker circuit board or one with a lower dielectric constant is used,

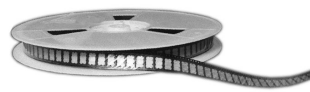
the interface pad will have less capacitive reactance than the Anaren test board. In this case, a wider section of line before the interface pad (or a larger interface pad) will introduce a shunt capacitance and when properly tuned will match the performance of the Anaren test board.

Notice that the board layout shown below is the same for all 0805 “J” size 2dB, 3dB, 4dB, 5dB, 3dB couplers.



USA/Canada: (315) 233-5510  
 Toll Free: (833) 389-6402  
 Europe: +44 2392-232392  
 Asia: +86 512 62749282

Available on Tape and Reel for Pick and Place Manufacturing.



**Anaren®**  
 What'll we think of next?®

## Testing Sample Parts Supplied on Anaren Test Boards

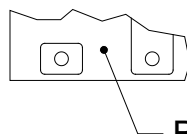
If you have received a coupler installed on an Anaren produced microstrip test board, please remember to remove the loss of the test board from the measured data. The loss is small enough that it is not of concern for Return Loss and Isolation/Directivity, but it should certainly be considered when measuring coupling and calculating the insertion loss of the coupler. An S-parameter file for a "Thru" board (see description of "Thru" board above) will be supplied upon request. As a first order approximation, one should consider the following loss estimates:

Frequency Band	Avg. Ins. Loss of Test Board @ 25°C
869-894 MHz	~0.195 dB
925-960 MHz	~0.208 dB
1805-1880 MHz	~0.358 dB
1930-1990 MHz	~0.376 dB
2110-2170 MHz	~0.406 dB
2200-2400 MHz	~0.439 dB
2500-2700 MHz	~0.481 dB
2800-3000 MHz	~0.506 dB
3000-3500 MHz	~0.549 dB
3500-4000 MHz	~0.581 dB
4000-6000 MHz	~0.757 dB
6000-8000 MHz	~0.943 dB

It is important to note that the loss of the test board will change with temperature and must be considered if the coupler is to be evaluated at other temperatures.

## Peak Power Handling

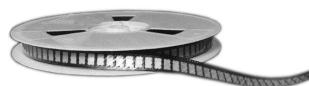
High-Pot testing of these couplers during the qualification procedure resulted in a minimum breakdown voltage of 1Kv (minimum recorded value). This voltage level corresponds to a breakdown resistance capable of handling at least 12dB peaks over average power levels, for very short durations. The breakdown location consistently occurred across the pads and the ground bar (see illustration below). The breakdown levels at these points will be affected by any contamination in the gap area around these pads. These areas must be kept clean for optimum performance. It is recommended that the user test for voltage breakdown under the maximum operating conditions and over worst case modulation induced power peaking. This evaluation should also include extreme environmental conditions (such as high humidity).



Breakdown Area

USA/Canada: (315) 233-5510  
 Toll Free: (833) 389-6402  
 Europe: +44 2392-232392  
 Asia: +86 512 62749282

Available on Tape and Reel for Pick and Place Manufacturing.



**Anaren®**  
 What'll we think of next?®



### Test Plan

Xinger couplers are manufactured in large panels and then separated. All parts are RF small signal tested at room temperature.

### Power Handling

The average power handling (total input power) of a Xinger coupler is a function of:

- Internal circuit temperature.
- Unit mounting interface temperature.
- Unit thermal resistance
- Power dissipated within the unit.

All thermal calculations are based on the following assumptions:

- The unit has reached a steady state operating condition.
- Maximum mounting interface temperature is 105°C.
- Conduction Heat Transfer through the mounting interface.
- No Convection Heat Transfer.
- No Radiation Heat Transfer.
- The material properties are constant over the operating temperature range.

Finite element simulations are made for each unit. The simulation results are used to calculate the unit thermal resistance. The finite element simulation requires the following inputs:

- Unit material stack-up.
- Material properties.
- Circuit geometry.
- Mounting interface temperature.
- Thermal load (dissipated power).

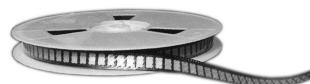
The classical definition for dissipated power is temperature delta ( $\Delta T$ ) divided by thermal resistance ( $R$ ). The dissipated power ( $P_{dis}$ ) can also be calculated as a function of the total input power ( $P_{in}$ ) and the thermal insertion loss ( $IL_{therm}$ ):

$$P_{dis} = \frac{\Delta T}{R} = P_{in} \cdot \left( 1 - 10^{-\frac{IL_{therm}}{10}} \right) \quad (W) \quad (1)$$

Power flow and nomenclature for an “X” style coupler is shown in Figure 1.

USA/Canada: (315) 233-5510  
Toll Free: (833) 389-6402  
Europe: +44 2392-232392  
Asia: +86 512 62749282

Available on Tape and  
Reel for Pick and Place  
Manufacturing.



**Anaren®**  
What'll we think of next?®

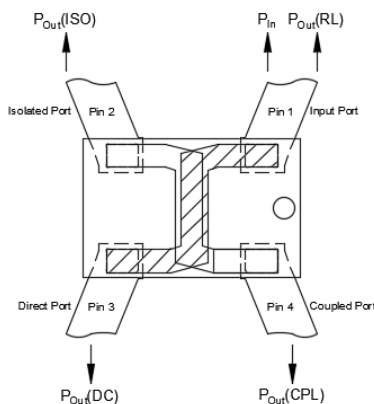


Figure 1

The coupler is excited at the input port with  $P_{in}$  (watts) of power. Assuming the coupler is not ideal, and that there are no radiation losses, power will exit the coupler at all four ports. Symbolically written,  $P_{out(RL)}$  is the power that is returned to the source because of impedance mismatch,  $P_{out(ISO)}$  is the power at the isolated port,  $P_{out(CPL)}$  is the power at the coupled port, and  $P_{out(DC)}$  is the power at the direct port.

At Anaren, insertion loss is defined as the log of the input power divided by the sum of the power at the coupled and direct ports:

Note: in this document, insertion loss is taken to be a positive number. In many places, insertion loss is written as a negative number. Obviously, a mere sign change equates the two quantities.

$$IL = 10 \cdot \log_{10} \left( \frac{P_{in}}{P_{out(CPL)} + P_{out(DC)}} \right) \quad (dB) \quad (2)$$

In terms of S-parameters, IL can be computed as follows:

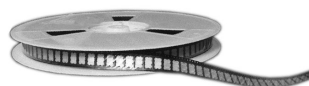
$$IL = -10 \cdot \log_{10} \left( |S_{31}|^2 + |S_{41}|^2 \right) \quad (dB) \quad (3)$$

We notice that this insertion loss value includes the power lost because of return loss as well as power lost to the isolated port.

For thermal calculations, we are only interested in the power lost “inside” the coupler. Since  $P_{out(RL)}$  is lost in the source termination and  $P_{out(ISO)}$  is lost in an external termination, they are not included in the insertion loss for thermal calculations. Therefore, we define a new insertion loss value solely to be used for thermal calculations:

$$IL_{therm} = 10 \cdot \log_{10} \left( \frac{P_{in}}{P_{out(CPL)} + P_{out(DC)} + P_{out(ISO)} + P_{out(RL)}} \right) \quad (dB) \quad (4)$$

In terms of S-parameters,  $IL_{therm}$  can be computed as follows:



$$IL_{therm} = -10 \cdot \log_{10} \left( |S_{11}|^2 + |S_{21}|^2 + |S_{31}|^2 + |S_{41}|^2 \right) \quad (dB) \quad (5)$$

The thermal resistance and power dissipated within the unit are then used to calculate the average total input power of the unit. The average total steady state input power ( $P_{in}$ ) therefore is:

$$P_{in} = \frac{P_{dis}}{\left( 1 - 10^{\frac{-IL_{therm}}{10}} \right)} = \frac{\frac{\Delta T}{R}}{\left( 1 - 10^{\frac{-IL_{therm}}{10}} \right)} \quad (W) \quad (6)$$

Where the temperature delta is the circuit temperature ( $T_{circ}$ ) minus the mounting interface temperature ( $T_{mnt}$ ):

$$\Delta T = T_{circ} - T_{mnt} \quad (^\circ C) \quad (7)$$

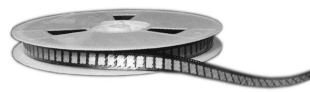
The maximum allowable circuit temperature is defined by the properties of the materials used to construct the unit. Multiple material combinations and bonding techniques are used within the Xinger product family to optimize RF performance. Consequently the maximum allowable circuit temperature varies. Please note that the circuit temperature is not a function of the Xinger case (top surface) temperature. Therefore, the case temperature cannot be used as a boundary condition for power handling calculations.

Due to the numerous board materials and mounting configurations used in specific customer configurations, it is the end users responsibility to ensure that the Xinger coupler mounting interface temperature is maintained within the limits defined on the power derating plots for the required average power handling. Additionally appropriate solder composition is required to prevent reflow or fatigue failure at the RF ports. Finally, reliability is improved when the mounting interface and RF port temperatures are kept to a minimum.

The power-derating curve illustrates how changes in the mounting interface temperature result in converse changes of the power handling of the coupler.

USA/Canada: (315) 233-5510  
 Toll Free: (833) 389-6402  
 Europe: +44 2392-232392  
 Asia: +86 512 62749282

Available on Tape and  
 Reel for Pick and Place  
 Manufacturing.



**Anaren®**  
 What'll we think of next?®

## Mounting

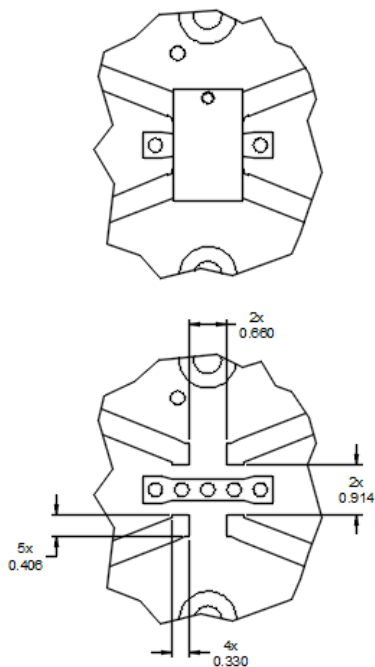
In order for Xinger surface mount couplers to work optimally, there must be 50Ω transmission lines leading to and from all of the RF ports. Also, there must be a very good ground plane underneath the part to ensure proper electrical performance. If either of these two conditions is not satisfied, electrical performance may not meet published specifications.

Overall ground is improved if a dense population of plated through holes connect the top and bottom ground layers of the PCB. This minimizes ground inductance and improves ground continuity. All of the Xinger hybrid and Hybrid couplers are constructed from ceramic filled PTFE composites, which possess excellent electrical and mechanical stability.

When a surface mount coupler is mounted to a printed circuit board, the primary concerns are; ensuring the RF pads of the device are in contact with the circuit trace of the PCB and insuring the ground plane of neither the component nor the PCB is in contact with the RF signal.

## Mounting Footprint

To ensure proper electrical and thermal performance there must be a ground plane with 100% solder connection on the ground bar as shown below.



Dimensions are in Millimeters

## Coupler Mounting Process

The process for assembling this component is a conventional surface mount process as shown in Figure 2. This process is conducive to both low and high volume usage.

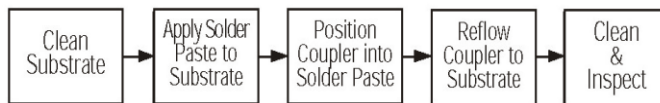
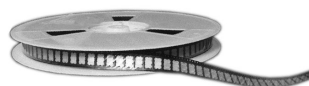


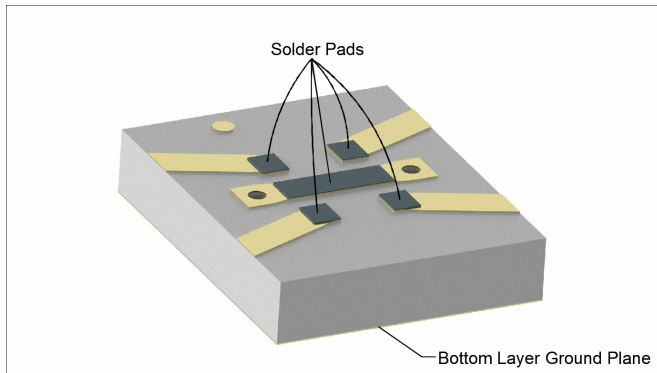
Figure 2: Surface Mounting Process Steps

**Storage of Components:** The Xinger products are available in an ENIG finish. IPC storage conditions used to control oxidation should be followed for these surface mount components.

**Substrate:** Depending upon the particular component, the circuit material has a coefficient of thermal expansion (CTE) similar to commonly used board substrates such as RF35, RO4003, FR4, polyimide and G-10 materials. The similarity in CTE minimizes solder joint stresses due to similar expansion rates between component and board. Mounting to “hard” substrates (alumina etc.) is possible depending upon operational temperature requirements. The solder surfaces of the coupler are all copper plated with an ENIG.

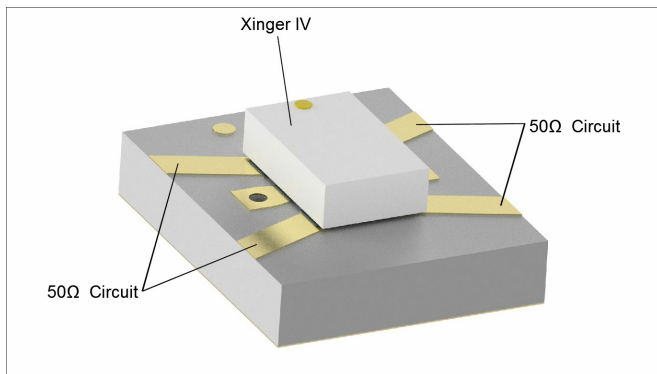
**Solder Paste:** All conventional solder paste formulations will work well with Anaren’s Xinger surface mount components. Solder paste can be applied with stencils or syringe dispensers. An example of a stenciled solder paste deposit is shown in Figure 3. As shown in the figure solder paste is applied to the four RF pads and the entire ground plane underneath the body of the part.



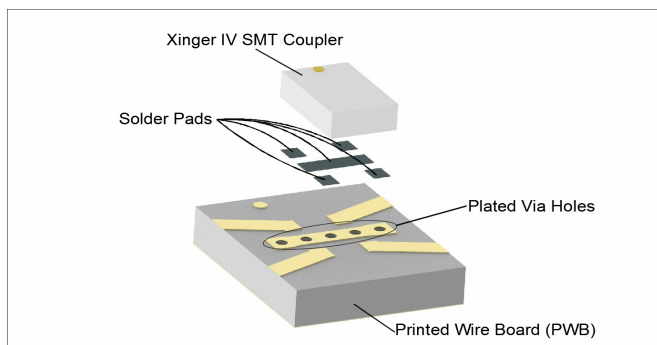


**Figure 3: Solder Paste Application**

**Component Positioning:** The surface mount component can be placed manually or with automatic pick and place mechanisms. Couplers should be placed (see Figure 4 and 5) onto wet paste with common surface mount techniques and parameters. Pick and place systems must supply adequate vacuum to hold a 0.01 gram coupler.



**Figure 4: Component Placement**

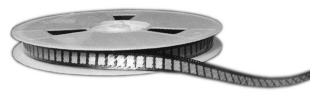


**Figure 5: Mounting Features Example**

**Reflow:** The surface mount coupler is conducive to most of today's conventional reflow methods. A low and high temperature thermal reflow profile are shown in Figures 6 and 7, respectively. Manual soldering of these components can be done with conventional surface mount non-contact hot air soldering tools. Board pre-heating is highly recommended for these selective hot air soldering methods. Manual soldering with conventional irons should be avoided.

USA/Canada: (315) 233-5510  
 Toll Free: (833) 389-6402  
 Europe: +44 2392-232392  
 Asia: +86 512 62749282

Available on Tape and Reel for Pick and Place Manufacturing.



**Anaren®**  
 What'll we think of next?®

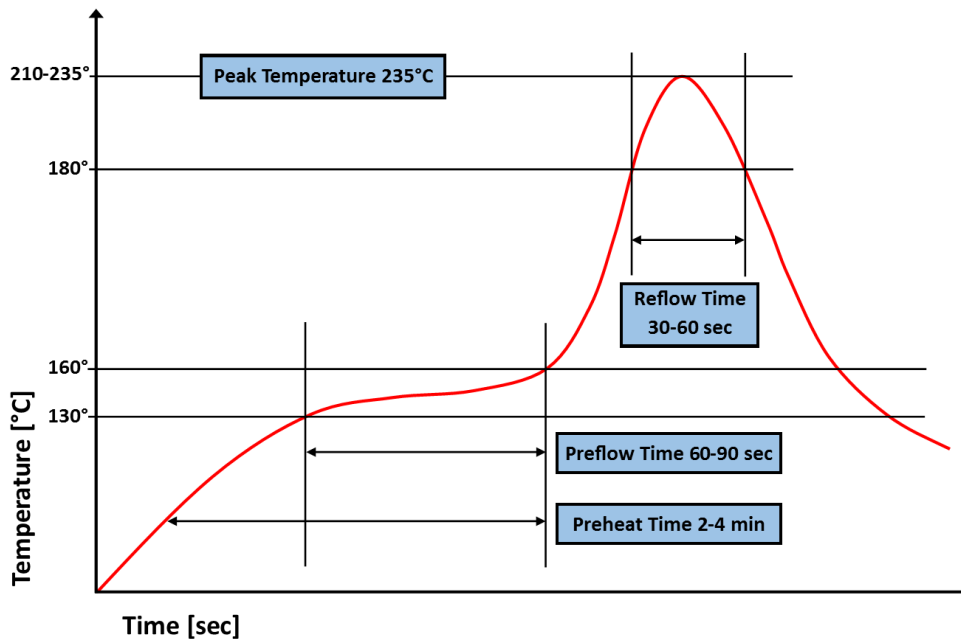


Figure 6 – Low Temperature Solder Reflow Thermal Profile

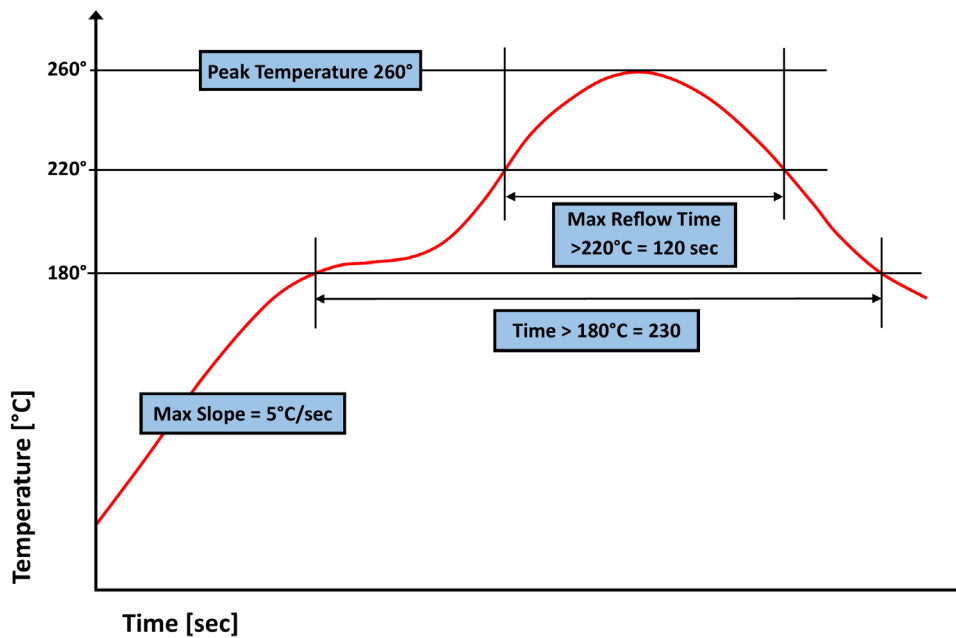
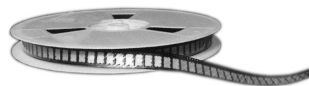


Figure 7 – High Temperature Solder Reflow Thermal Profile

USA/Canada: (315) 233-5510  
 Toll Free: (833) 389-6402  
 Europe: +44 2392-232392  
 Asia: +86 512 62749282

Available on Tape and Reel for Pick and Place Manufacturing.



### Packaging and Ordering Information

Parts are available in reel and are packaged per EIA 481-D. Parts are oriented in tape and reel as shown below. Minimum order quantities are 4000 per reel.

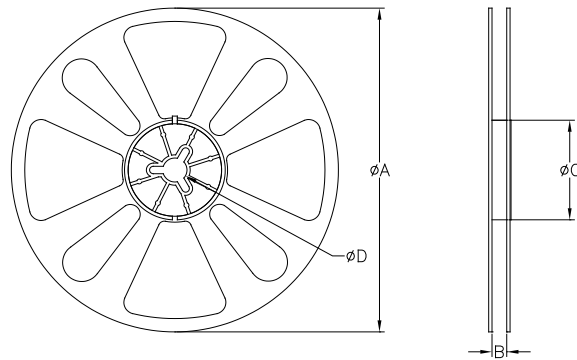
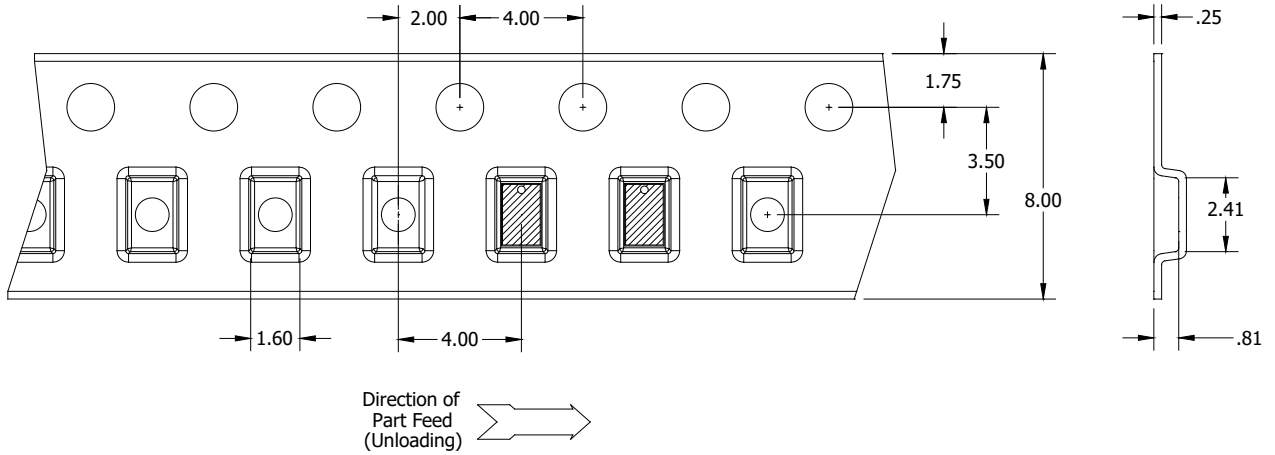
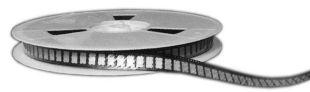


TABLE 1		
QUANTITY/REEL	REEL DIMENSIONS mm	
4000	φA	177.80
	B	8.00
	φC	50.80
	φD	13.00

USA/Canada: (315) 233-5510  
 Toll Free: (833) 389-6402  
 Europe: +44 2392-232392  
 Asia: +86 512 62749282

Available on Tape and Reel for Pick and Place Manufacturing.



**Anaren®**  
 What'll we think of next?®