



**RAD HARD ULTRA LOW
DROPOUT ADJUSTABLE
POSITIVE LINEAR REGULATOR**

5805RH

FEATURES:

- Manufactured using  Space Qualified RH1573 Die
- Total Dose Hardened to 300 Krads(Si) (Method 1019.7 Condition A)
- Ultra Low Dropout for Reduced Power Consumption
- External Shutdown/Reset Function
- Latching Overload Protection
- Adjustable Output Using Two External Resistors
- User Adjustable Current Limit
- Surface Mount Package Available with Lead Forming
- Greater than 1.0A Output Current
- Non-Rad Hard EDU Version Available

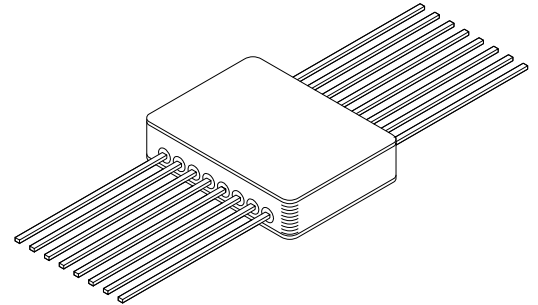

DESCRIPTION:

The MSK5805RH is a rad hard adjustable linear regulator capable of delivering greater than 1.0 amp of output current. The typical dropout is only 0.10 volts at 0.5 amp. An external shutdown/reset function is ideal for power supply sequencing. This device also has latching overload protection that requires no external current sense resistor. The MSK5805RH is radiation hardened and specifically designed for many space/satellite applications. The device is packaged in a hermetically sealed 16 pin flatpack that can be lead formed for surface mount applications.

EQUIVALENT SCHEMATIC

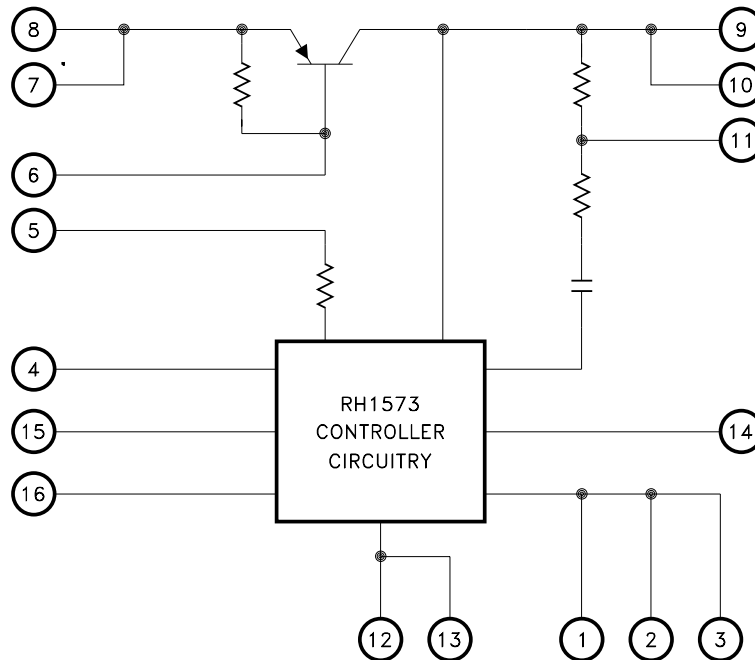

TYPICAL APPLICATIONS

- Satellite System Power Supplies
- Switching Power Supply Post Regulators
- Constant Voltage/Current Regulators
- Microprocessor Power Supplies

PIN-OUT INFORMATION

1	GND2	9	VOUTA
2	GND2	10	VOUTB
3	GND2	11	VOUT SENSE
4	VBIAS	12	GND1
5	IADJ1	13	GND1
6	IADJ2	14	FB
7	VINA	15	LATCH
8	VINB	16	SHUT DOWN

 and the Linear Technology logo are registered trademarks and RH1573 is a copyright of Linear Technology Corporation

ABSOLUTE MAXIMUM RATINGS ^⑧

VBIAS	Bias Supply Voltage.....	10V
VIN	Supply Voltage.....	10V
VSD	Shutdown Voltage.....	10V
IOUT	Output Current ^⑦	2A
Tc	Case Operating Temperature Range	
	MSK5805K/H RH.....	-55°C to +125°C
	MSK5805RH.....	-40°C to +85°C

T _{ST}	Storage Temperature Range.....	-65°C to +150°C
T _{LD}	Lead Temperature Range	
	(10 Seconds).....	300°C
P _D	Power Dissipation.....	See SOA Curve
T _c	Junction Temperature.....	150°C
	ESD Rating.....	Class 2

ELECTRICAL SPECIFICATIONS

Parameter	Test Conditions ^{① ⑨}	Group A Subgroup	MSK5805K/H RH			MSK5805RH/EDU			Units	
			Min.	Typ.	Max.	Min.	Typ.	Max.		
Input Voltage Range ^②	10mA ≤ I _{OUT} ≤ 0.5A	1,2,3	2.0	–	7.5	2.0	–	7.5	V	
Input Bias Voltage ^②	VBIAS ≥ VIN	1,2,3	2.9	5.0	7.5	2.9	5.0	7.5	V	
Feedback Voltage (V _{FB})	V _{OUT} = V _{FB} 2.9V ≤ VIN ≤ 7.5V 10mA ≤ I _{OUT} ≤ 1.0A	1,3	1.225	1.265	1.305	1.225	1.265	1.305	V	
		Post 100KRAD(Si)	1	1.225	–	1.305	–	–	–	V
		Post 300KRAD(Si)	1	1.225	–	1.310	–	–	–	V
		^⑩ 10mA ≤ I _{OUT} ≤ 0.5A	2	1.225	–	1.305	–	–	–	V
Feedback Pin Current ^②	V _{FB} = 1.265V 10mA ≤ I _{OUT} ≤ 0.5A	1,2,3	0	–	5.0	0	–	5.0	μA	
Quiescent Current	I _{IN} + I _B IAS, VBIAS = VIN = 7.5V Not including I _{OUT}	1,2,3	–	5.5	10	–	5.5	10	mA	
Bias Current	VBIAS = 7.5V	1,2,3	–	2	4	–	2	4	mA	
Line Regulation	I _{OUT} = 10mA 2.9V ≤ VIN ≤ 7.5V V _{OUT} = V _{FB}	1	–	±0.01	±0.50	–	0.01	±0.60	%V _{OUT}	
		2,3	–	–	±0.50	–	–	–	%V _{OUT}	
Load Regulation	10mA ≤ I _{OUT} ≤ 1.0A V _{OUT} = V _{FB}	1	–	±0.06	±0.80	–	0.06	±1.0	%V _{OUT}	
		2,3	–	–	±0.80	–	–	–	%V _{OUT}	
Dropout Voltage	Delta FB = 1% I _{OUT} = 0.5A	1	–	0.10	0.30	–	0.10	0.30	V	
		2,3	–	0.10	0.30	–	–	–	V	
Minimum Output Current ^②	2.9V ≤ VIN ≤ 7.5V R ₁ = 187Ω	1	–	8	10	–	8	10	mA	
		2,3	–	9	10	–	–	–	mA	
Output Voltage Range ^②	VIN = 7.5V	–	1.5	–	7.0	1.5	–	7.0	V	
Output Current Limit ^⑦	VIN = 2.5V V _{OUT} = 1.5V R _{ADJ} = 0Ω	1	1.3	1.5	1.7	1.3	1.5	1.7	A	
		2,3	1.1	–	1.9	–	–	–	A	
Shutdown Threshold	V _{OUT} ≤ 0.2V (OFF) V _{OUT} = Nominal (ON)	1	1.0	1.3	1.6	1.0	1.3	1.6	V	
		2,3	1.0	1.3	1.6	–	–	–	V	
Shutdown Hysteresis	Difference between voltage threshold of V _{SDI} (ON) AND V _{SDI} (OFF)	1	–	0.02	0.2	–	0.02	0.2	V	
		2,3	–	0.03	0.2	–	–	–	V	
Ripple Rejection ^②	f = 1KHz to 10KHz 10mA ≤ I _{OUT} ≤ 0.5A 1.0V = VIN – V _{OUT}	4	20	–	–	20	–	–	dB	
		5,6	20	–	–	–	–	–	dB	
Phase Margin ^②	V _{OUT} = 1.5V 10mA ≤ I _{OUT} ≤ 1A	4,5,6	45	–	–	45	–	–	degrees	
Gain Margin ^②	V _{OUT} = 1.5V 10mA ≤ I _{OUT} ≤ 1A	4,5,6	13	–	–	13	–	–	dB	
Equivalent Noise Voltage ^②	Referred to Feedback Pin	4,5,6	–	–	50	–	–	50	μVRMS	
Thermal Resistance ^②	Junction to Case ^⑩ 125°C Output Device	–	–	7.6	11.5	–	7.6	11.5	°C/W	

NOTES:

- ① Unless otherwise specified, VBIAS = VIN = 5.0V, R₁ = 1.62K, V_{SHUTDOWN} = 0V and I_{OUT} = 10mA. I_{OUT} is subtracted from I_Q measurement. See typical application circuit.
- ② Guaranteed by design but not tested. Typical parameters are representative of actual device performance but are for reference only.
- ③ Industrial grade devices shall be tested to subgroups 1 and 4 unless otherwise requested.
- ④ Military grade devices ("H" and "K" suffix) shall be 100% tested to subgroups 1,2,3 and 4.
- ⑤ Subgroup 5 and 6 testing available upon request.
- ⑥ Subgroup 1,4 T_c = +25°C
Subgroup 2,5 T_c = +125°C
Subgroup 3,6 T_a = -55°C
- ⑦ Output current limit is tested with a low duty cycle pulse to minimize junction heating and is dependent on the values of VIN, V_{OUT} and case temperature. See Typical Performance Curves.
- ⑧ Continuous operation at or above absolute maximum ratings may adversely effect the device performance and/or life cycle.
- ⑨ Pre and post irradiation limits @ 25°C, up to 300 Krad TID, are identical unless otherwise specified. Not applicable to EDU devices.
- ⑩ Limited by S.O.A.

APPLICATION NOTES

PIN FUNCTIONS

VIN A,B - These pins provide the input power connection to the MSK5805RH. This is the supply that will be regulated to the output. Both pins must be connected for proper operation.

VBIAS - This pin provides power to all internal circuitry including bias, start-up, thermal limit and overcurrent latch. VBIAS voltage range is 2.9V to 7.5V. VBIAS should be kept greater than or equal to VIN.

GND1 - Internally connected to signal ground, these pins should be connected externally by the user to the circuit ground and the GND2 pins.

LATCH - The MSK5805RH LATCH pin is used for both current limit and thermal limit. A capacitor between the LATCH pin and ground sets a time out delay in the event of an over current or short circuit condition. The capacitor is charged to approximately 1.6V from a 7.2 μ A (nominal) current source. Exceeding the thermal limit will charge the latch capacitor from a larger current source for a near instant shutdown. Once the latch capacitor is charged the device latches off until the latch is reset. Momentarily pull the LATCH pin low, toggle the shutdown pin high then low or cycle the power to reset the latch. Toggling the shutdown pin or cycling the bias power both disable the device during the reset operation (see SHUTDOWN pin description). Pulling the LATCH pin low immediately enables the device for as long as the LATCH pin is held low plus the time delay to re-charge the latch capacitor whether or not the fault has been corrected. Disable the latch feature by tying the LATCH pin low. With the LATCH pin held low the thermal limit feature is disabled and the current limit feature will force the output voltage to droop but remain active if excessive current is drawn.

SHUTDOWN - There are two functions to the SHUTDOWN pin. It may be used to disable the output voltage or to reset the LATCH pin. To activate the shutdown/reset functions the user must apply a voltage greater than 1.3V to the SHUTDOWN pin. The voltage applied to the SHUTDOWN pin can be greater than the input voltage. The output voltage will turn on when the SHUTDOWN pin is pulled below the threshold voltage. If the SHUTDOWN pin is not used, it should be connected to ground.

FB - The FB pin is the inverting input of the internal error amplifier. The non-inverting input is connected to an internal 1.265V reference. This error amplifier controls the drive to the output transistor to force the FB pin to 1.265V. An external resistor divider is connected to the output, FB pin and ground to set the output voltage.

GND2 - Internally connected to power ground, these pins should be connected externally by the user to the circuit ground and the GND1 pins.

VOUT A,B - These are the output pins for the device. Both pins must be connected for proper operation.

IADJ1 AND IADJ2 - The IADJ pins provide a method to adjust the current limit. The current limit of the MSK5805RH is sensitive to the input voltage. For lower input voltages the current limit is reduced. For higher input voltages current limit is increased. Place a short across IADJ1 and IADJ2 for maximum current. Place a resistor across IADJ1 and IADJ2 to decrease the current limit.

OUTPUT CAPACITOR SELECTION

Low ESR capacitance at the output is required to maintain regulation and stability. A single 150 μ A (AVX PN TAZX157K010L) in parallel with ceramic decoupling capacitance (0.01 μ F typical) ensure good stability margins and transient performance for the broadest range of applications. Lower value output capacitors can also provide acceptable performance in applications with defined operating ranges. For example, a single 47 μ F (AVX PN TAZH476K010L) performs well in lower current applications. Additional frequency response compensation can be implemented with a simple RC network from pin 6 to the output or ground. Reference the MSK5805RH Evaluation Card Application Note (AN033) for more information.

POWER SUPPLY BYPASSING

To maximize transient response and minimize power supply transients it is recommended that a 33 μ F minimum tantalum capacitor is connected between VIN and ground. A 0.1 μ F ceramic capacitor should also be used for high frequency bypassing.

START UP OPTIONS

The MSK5805RH starts up and begins regulating immediately when VBIAS and VIN are applied simultaneously. Applying VBIAS before VIN starts the MSK5805RH up in a disabled or latched state. When starting in a latched state the device output can be enabled either by pulling the latch pin low to drain the latch capacitor or pulsing the shutdown pin high. The shutdown pulse duration is partially dependent upon the size of the latch capacitor and should be characterized for each application; 30 μ s is typically adequate for a 1 μ F latch capacitor at 25°C. A momentary high pulse on the shutdown pin can be achieved using the RC circuit below if VIN rises rapidly. The resistor and capacitor must be selected based on the required pulse duration, the rise characteristic of VIN and the shutdown pin threshold (see shutdown pin threshold and current curves).

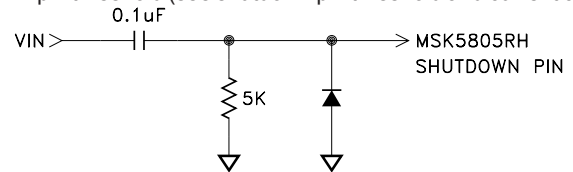

The shutdown pin can be held high and pulled low after VIN comes up or the latch pin held low and released after VIN comes up to ensure automatic startup when applying VBIAS before VIN. Either of the basic circuits below can be adapted to a variety of applications for automatic start up when VBIAS rises before VIN.

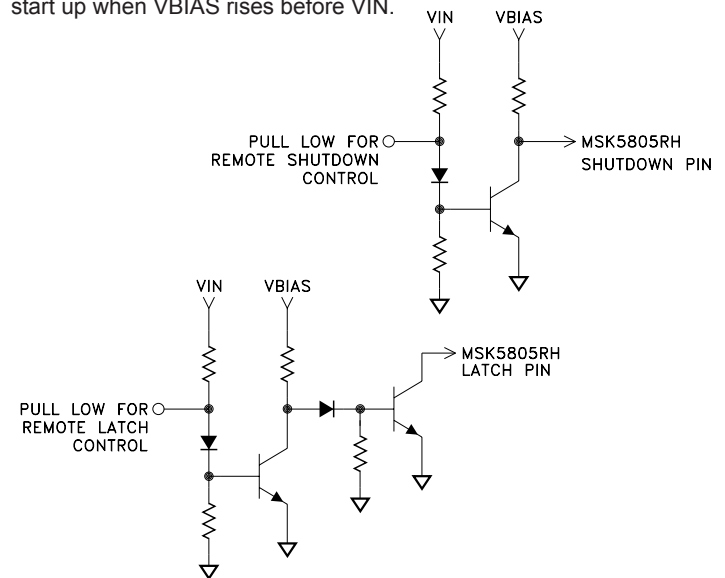

OVERCURRENT LATCH-OFF/LATCH PIN CAPACITOR SELECTION

As previously mentioned, the LATCH pin provides over current/output short circuit protection with a timed latch-off circuit. Reference the LATCH pin description note. The latch off time out is determined with an external capacitor connected from the LATCH pin to ground. The time-out period is equal to the time it takes to charge this external capacitor from 0V to 1.6V. The latch charging current is provided by an internal current source. This current is a function of bias voltage and temperature (see latch charging current curve). For instance, at 25°C, the latch charging current is 7.2 μ A at VBIAS=3V and 8 μ A at VBIAS=7V.

In the latch-off mode, some additional current will be drawn from the bias supply. This additional latching current is also a function of bias voltage and temperature (see typical performance curves).

The MSK5805RH current limit function is directly affected by the input and output voltages. Custom current limit is available; contact the factory for more information.

THERMAL LIMITING

The MSK5805RH control circuitry has a thermal shutdown temperature of approximately 150°C. This thermal shutdown can be used as a protection feature, but for continuous operation, the junction temperature of the pass transistor must be maintained below 150°C. Proper heat sink selection is essential to maintain these conditions. Exceeding the thermal limit activates the latch feature of the MSK5805RH. See LATCH pin description for instructions to reset the latch or disable the latch feature.

HEAT SINK SELECTION

To select a heat sink for the MSK5805RH, the following formula for convective heat flow may be used.

Governing Equation:

$$T_J = P_D \times (R_{\theta JC} + R_{\theta CS} + R_{\theta SA}) + T_A$$

Where

- T_J = Junction Temperature
- P_D = Total Power Dissipation
- R_{θJC} = Junction to Case Thermal Resistance
- R_{θCS} = Case to Heat Sink Thermal Resistance
- R_{θSA} = Heat Sink to Ambient Thermal Resistance
- T_A = Ambient Temperature

$$\text{Power Dissipation} = (V_{IN} - V_{OUT}) \times I_{OUT}$$

Next, the user must select a maximum junction temperature. The absolute maximum allowable junction temperature is 150°C. The equation may now be rearranged to solve for the required heat sink to ambient thermal resistance (R_{θSA}).

Example:

An MSK5805RH is connected for V_{IN}=+5V and V_{OUT}=+3.3V. I_{OUT} is a continuous 0.5A DC level. The ambient temperature is +25°C. The maximum desired junction temperature is +125°C.

R_{θJC}=7.5°C/W and R_{θCS}=0.15°C/W for most thermal greases

$$\text{Power Dissipation} = (5V - 3.3V) \times (0.5A) = 0.85\text{Watts}$$

Solve for R_{θSA}:

$$R_{\theta SA} = \left[\frac{125^\circ\text{C} - 25^\circ\text{C}}{0.85\text{W}} \right] - 7.5^\circ\text{C/W} - 0.15^\circ\text{C/W} = 110^\circ\text{C/W}$$

In this example, a heat sink with a thermal resistance of no more than 110°C/W must be used to maintain a junction temperature of no more than 125°C.

TYPICAL APPLICATIONS CIRCUIT

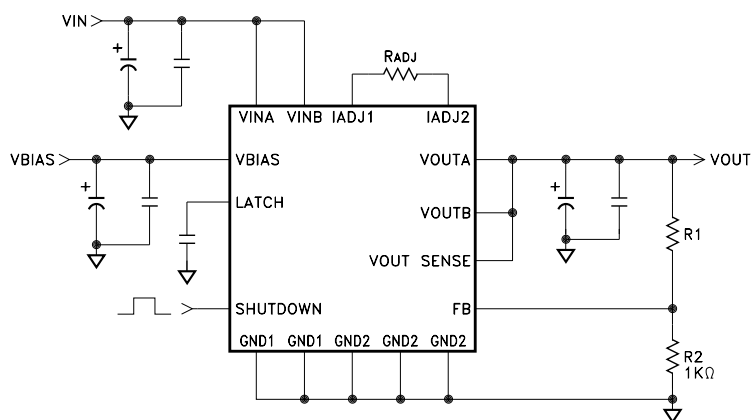

$$V_{OUT} = 1.265(1 + R1/R2)$$

OUTPUT VOLTAGE SELECTION

As noted in the above typical applications circuit, the formula for output voltage selection is

$$V_{OUT} = 1.265 \left[1 + \frac{R1}{R2} \right]$$

A good starting point for this output voltage selection is to set R₂=1K. By rearranging the formula it is simple to calculate the final R₁ value.

$$R1 = R2 \left[\frac{V_{OUT}}{1.265} - 1 \right]$$

START UP CURRENT

The MSK5805RH requires less startup current than other RH1573 based regulators in this series. LDO regulators sink increased current during startup to bring up the output voltage. The MSK5805RH was designed to require less startup current making it ideal for lower current applications. The startup current can be further reduced by placing a resistor (RADJ) between the LADJ pins for lower current applications. The use of RADJ decreases the saturated start up current and the current limit of the device. Reference the "Current Limit vs. RADJ" graph and "Saturated Start Up Current vs. Input Voltage" graph in the typical performance curves section of this data sheet. See AN 024 "Understanding Start Up Surge Current With MS Kennedy's RH1573 based Rad Hard LDO Regulators" in the application notes section of MSK's web site for additional information.

<http://www.anaren.com/msk>

TOTAL DOSE RADIATION TEST PERFORMANCE

Radiation performance curves for TID testing will be generated for all radiation testing performed by MSK. These curves show performance trends throughout the TID test process and can be located in the MSK5805RH radiation test report. The complete radiation test report will be available in the RAD HARD PRODUCTS section on the MSK website.

TYPICAL PERFORMANCE CURVES

LATCH PIN LATCH-OFF THRESHOLD vs. VBIAS VOLTAGE

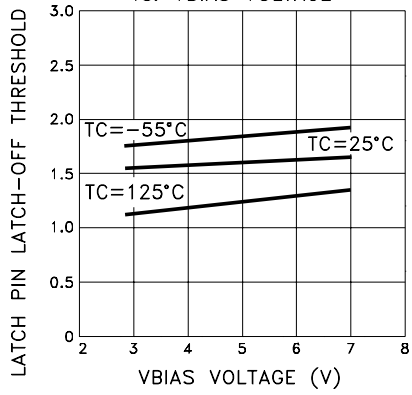

LATCHING CURRENT vs. VBIAS VOLTAGE

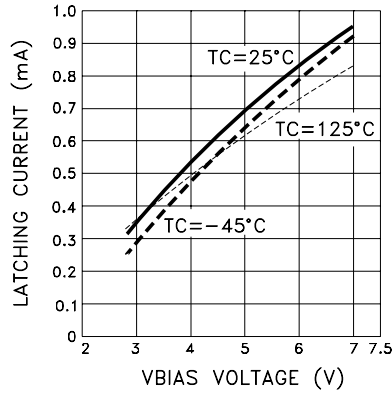

LATCH CHARGING CURRENT vs. VBIAS VOLTAGE

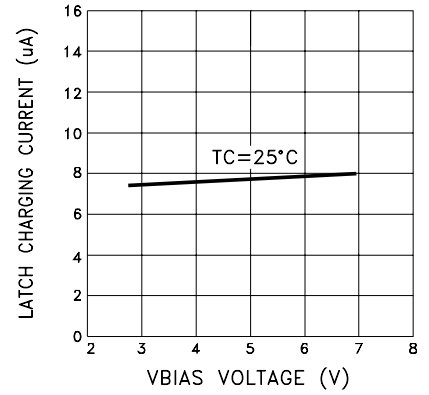

SHUTDOWN VOLTAGE THRESHOLD vs. TEMPERATURE

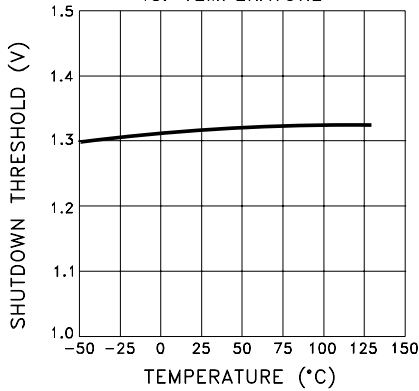

FEEDBACK PIN BIAS CURRENT vs. TEMPERATURE

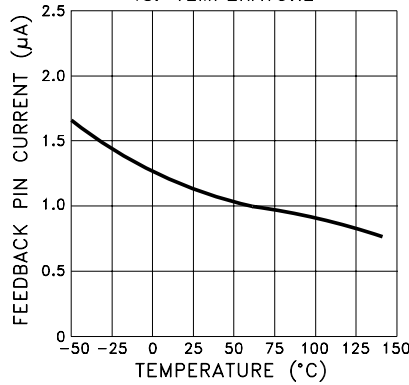

FEEDBACK PIN VOLTAGE vs. TEMPERATURE

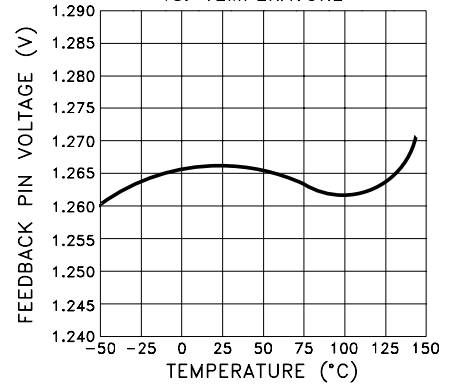

SHUTDOWN PIN CURRENT vs. SHUTDOWN PIN VOLTAGE

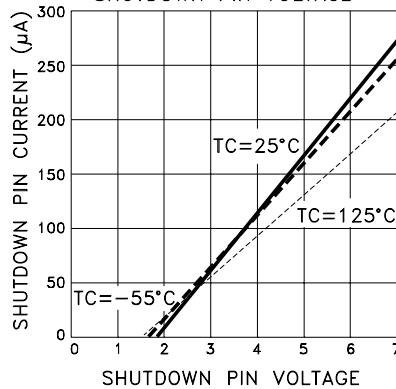

TYPICAL PERFORMANCE CURVES CONT'D

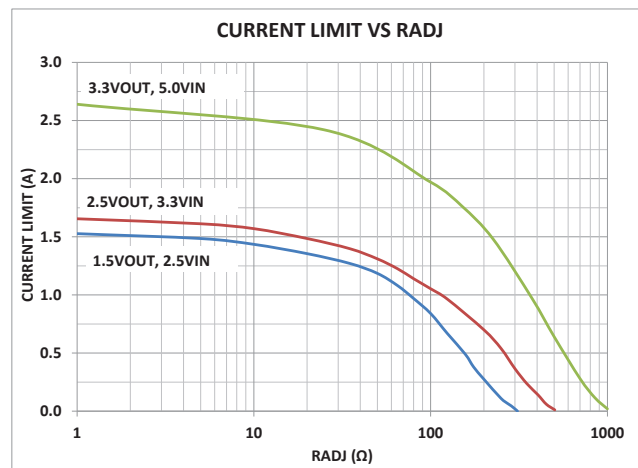
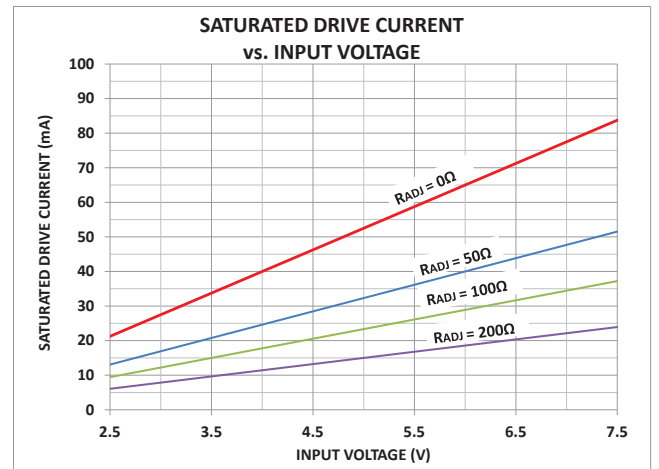
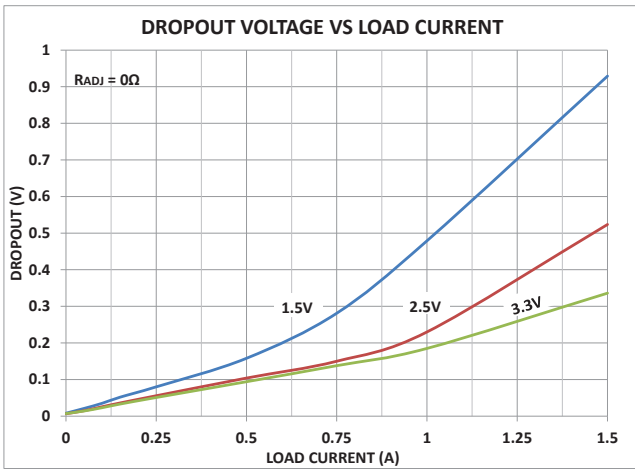
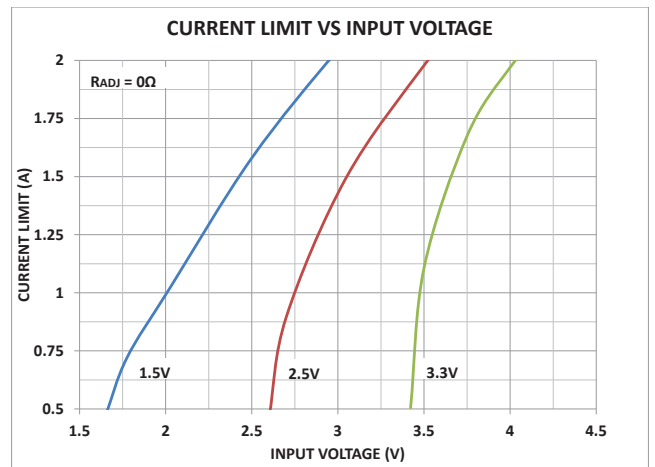
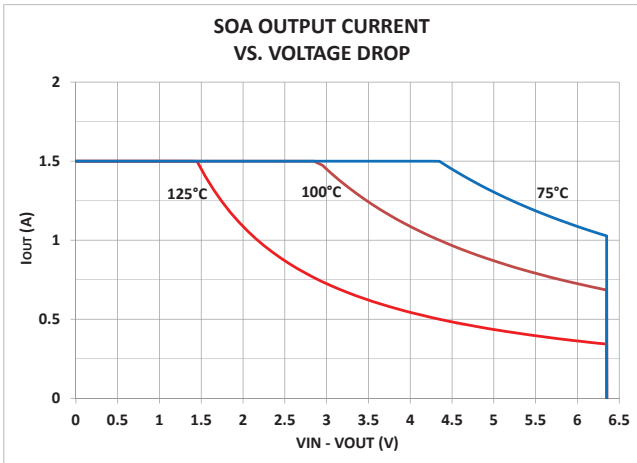

GAIN AND PHASE RESPONSE

The gain and phase response curves are for the MSK typical application circuit and are representative of typical device performance, but are for reference only. The performance should be analyzed for each application to insure individual program requirements are met. External factors such as temperature, input and output voltages, capacitors, etc. all can be major contributors. Please consult factory for additional details.

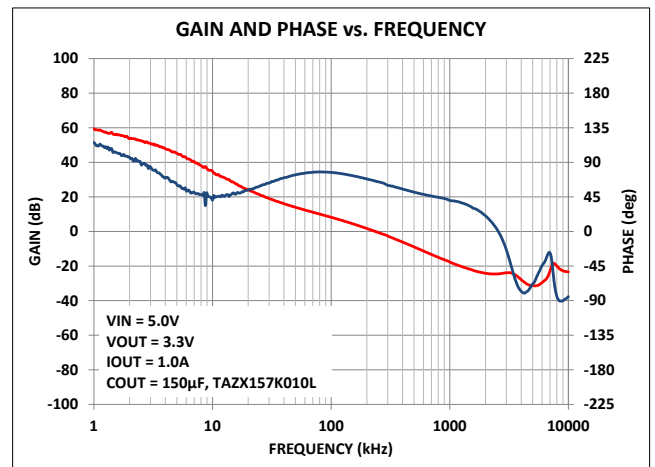
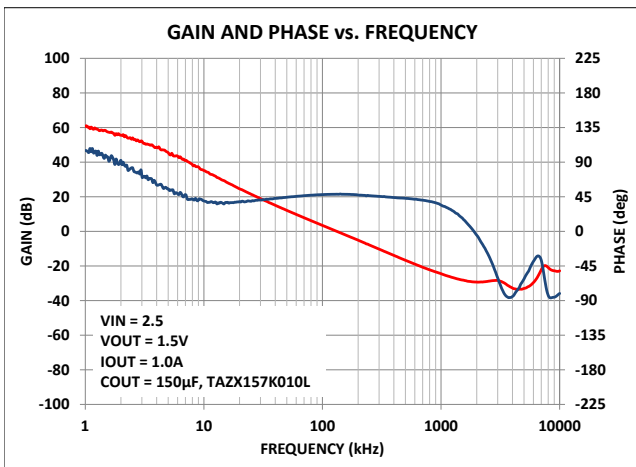
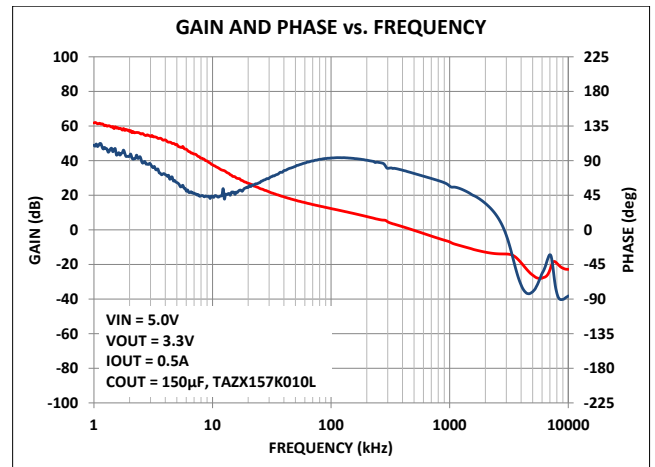
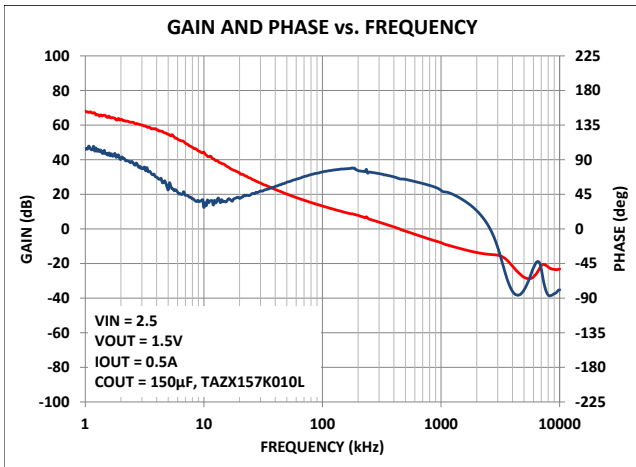
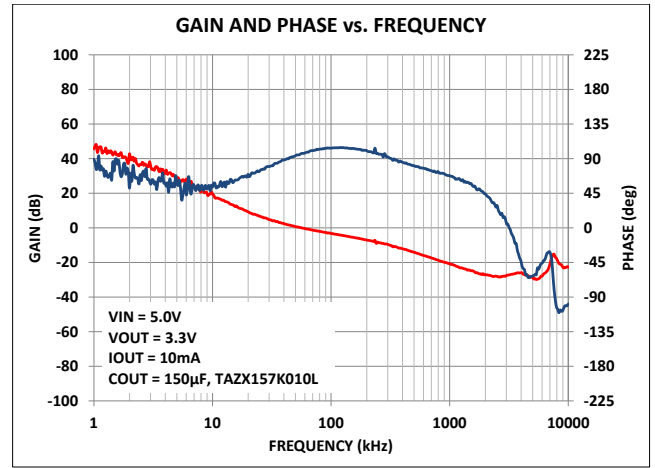
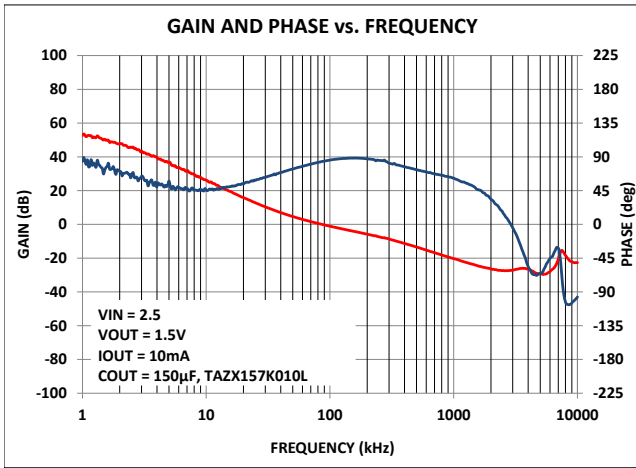

GAIN AND PHASE RESPONSE

The gain and phase response curves are for the MSK typical application circuit and are representative of typical device performance, but are for reference only. The performance should be analyzed for each application to insure individual program requirements are met. External factors such as temperature, input and output voltages, capacitors, etc. all can be major contributors. Please consult factory for additional details.

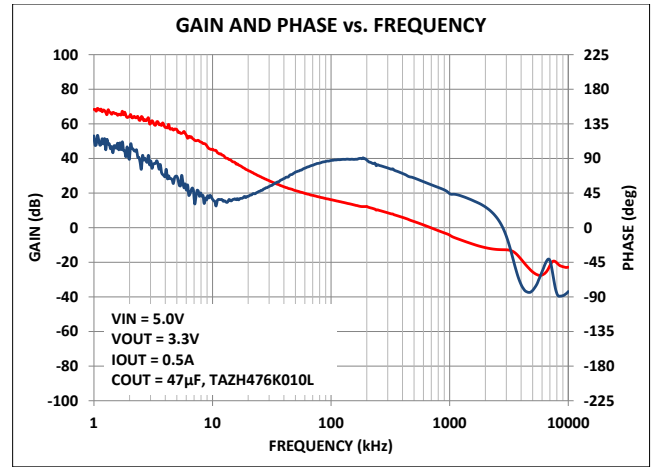
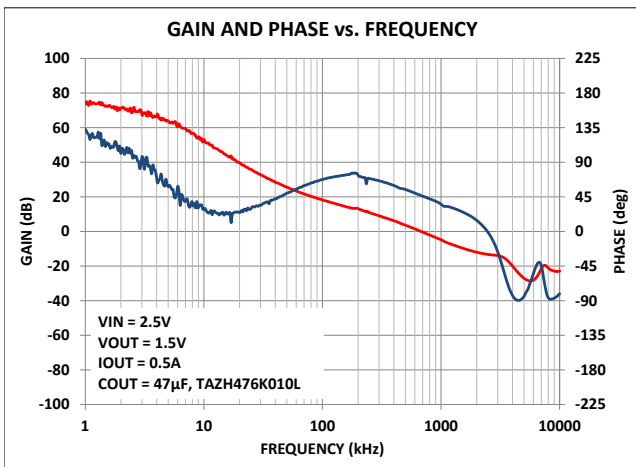
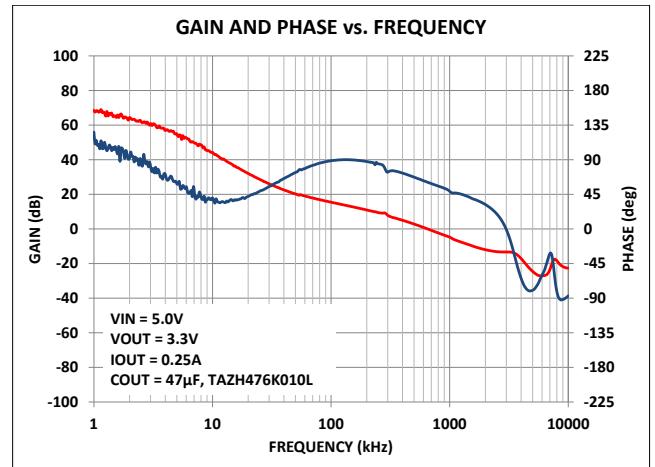
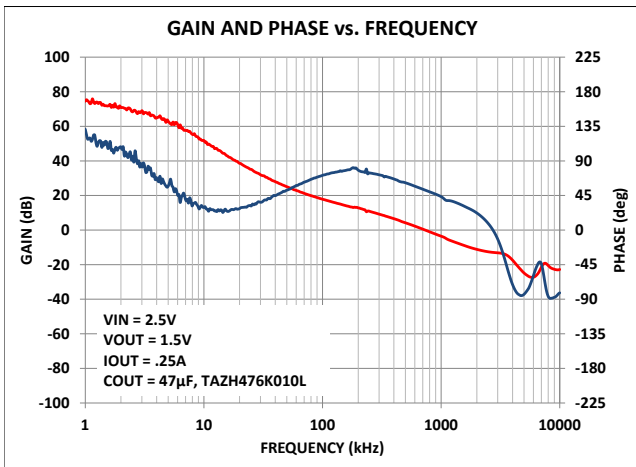
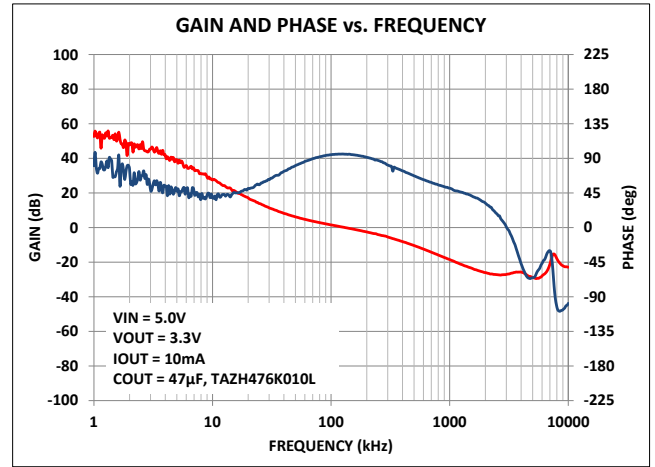
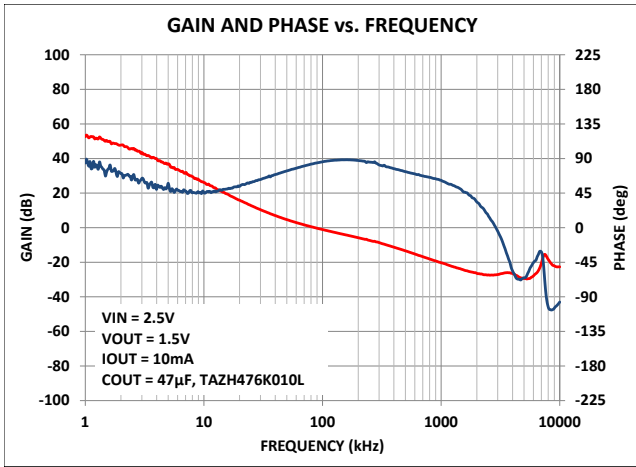

MECHANICAL SPECIFICATIONS

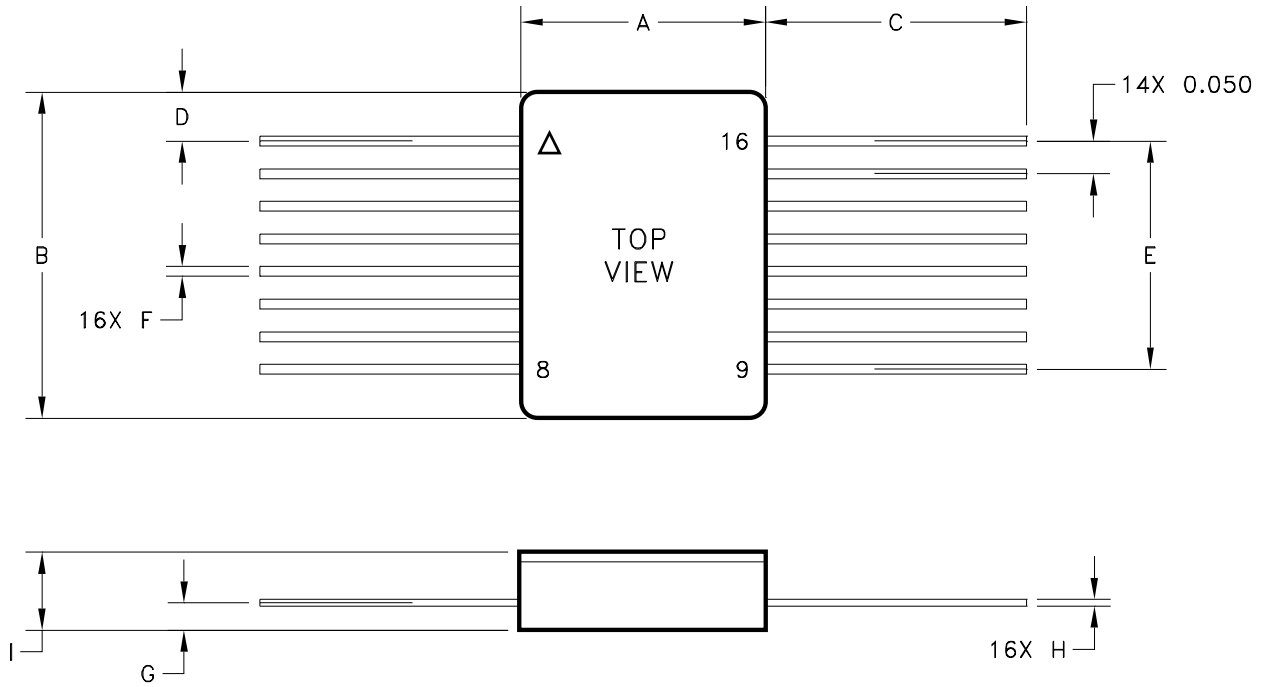

REF	MIN	MAX
A	0.365	0.385
B	0.490	0.510
C	0.400	—
D	0.075 REF	
E	0.345	0.355
F	0.012	0.018
G	0.032	0.052
H	0.008	0.012
I	—	0.115

ESD TRIANGLE INDICATES PIN 1
WEIGHT=1.45 GRAMS TYPICAL

ALL DIMENSIONS ARE SPECIFIED IN INCHES

ORDERING INFORMATION

PART NUMBER	SCREENING LEVEL	LEADS
MSK5805EDU	NON-RAD HARD ENG UNITS	STRAIGHT
MSK5805RH	INDUSTRIAL	
MSK5805HRH	MIL-PRF-38534 CLASS H	
MSK5805KRH	MIL-PRF-38534 CLASS K	
TBD	DSCC SMD	

MECHANICAL SPECIFICATIONS CONT'D

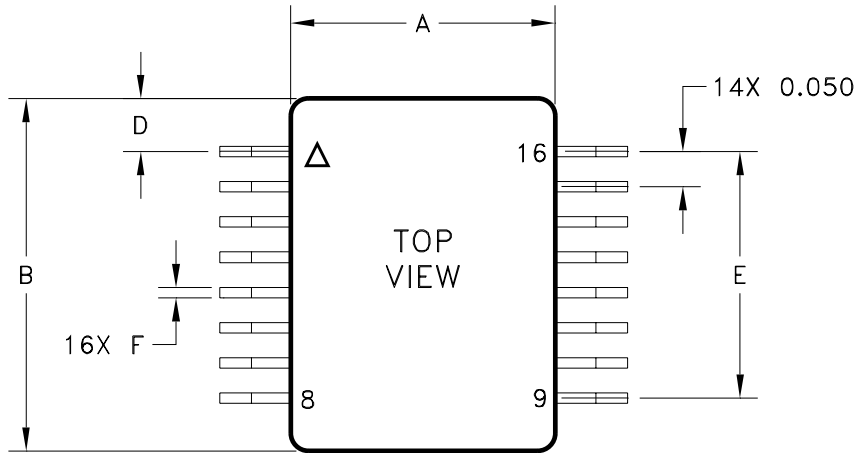

REF	MIN	MAX
A	0.365	0.385
B	0.490	0.510
C	0.045	0.055
D	0.075 REF	
E	0.345	0.355
F	0.012	0.018
G	0.050 REF	
H	0.008	0.012
I	—	0.115
J	0.008	0.018
K	0.550	0.600

NOTE: "J" IS MEASURED FROM BOTTOM OF PIN TO BOTTOM OF CASE.

ESD TRIANGLE INDICATES PIN 1
WEIGHT=1.45 GRAMS TYPICAL

ALL DIMENSIONS ARE SPECIFIED IN INCHES

ORDERING INFORMATION

PART NUMBER	SCREENING LEVEL	LEADS
MSK5805EDUG	NON-RAD HARD ENG UNITS	GULL WING
MSK5805RHG	INDUSTRIAL	
MSK5805HRHG	MIL-PRF-38534 CLASS H	
MSK5805KRHG	MIL-PRF-38534 CLASS K	
TBD	DSCC SMD	

REVISION HISTORY

REV	STATUS	DATE	DESCRIPTION
B	Released	03/14	Correct equivalent schematic and quiescent current specifications, add ESD rating
C	Released	06/14	Add shutdown pin to absolute maximum ratings and comment in shutdown pin description.
D	Released	01/15	Format and editorial changes, clarify radiation status and dimensions.
E	Released	03/15	Change RTHETA _{jc} from 11 to 11.5 °C/W update SOA curve.
F	Released	05/15	Correct R _{θSA} formula in heat sink selection.

MSK
www.anaren.com/msk

The information contained herein is believed to be accurate at the time of printing. MSK reserves the right to make changes to its products or specifications without notice, however, and assumes no liability for the use of its products. Please visit our website for the most recent revision of this datasheet.