



M.S.KENNEDY CORP.

**RAD HARD QUAD PRECISION  
RAIL TO RAIL  
CURRENT SENSE AMP**

**496RH**

**FEATURES:**



- Manufactured using LINEAR TECHNOLOGY RH6105 Dice
- Radiation Hardened to 100 Krad(Si) (Method 1019.7 Condition A)
- Low Dose Rate Hardened to 50 Krad(Si) (Method 1019.7 Condition D)
- Neutron Tested to  $5 \times 10^{11}$  n/cm<sup>2</sup> (Method 1017.2)
- Very Wide Input Common Mode Range
  - Extends 44V Above V- (Independent of V+)
  - Extends -0.3V Below V-
- Wide Power Supply Range: 2.85V to 36V
- Input Offset Voltage: 400 $\mu$ V Maximum
- Gain Accuracy: 1% Max
- Gain Configurable with External Resistors
- Operating Current: 195 $\mu$ A typ. per Amp
- Slew Rate: 2V/ $\mu$ s
- Sense Input Current When Powered Down: < 1 $\mu$ A
- Full-Scale Output Current: 1mA Minimum
- Non-Rad Hard EDU's Available

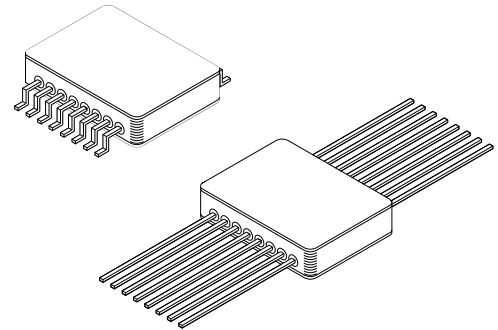

**DESCRIPTION:**

The MSK496RH is a radiation hardened quad precision micropower current sense amplifier with a very wide input common mode range. With Over-the-Top<sup>®</sup> Technology, the MSK496RH is capable of sensing in high side or low side applications. This combined with external gain setting, and common mode and power supply rejection in excess of 100dB, make the MSK496RH well suited for a variety of current sensing applications. The MSK496RH is hermetically sealed in a 16 pin flat pack, and is available with straight or gull wing lead form.

**EQUIVALENT SCHEMATIC**

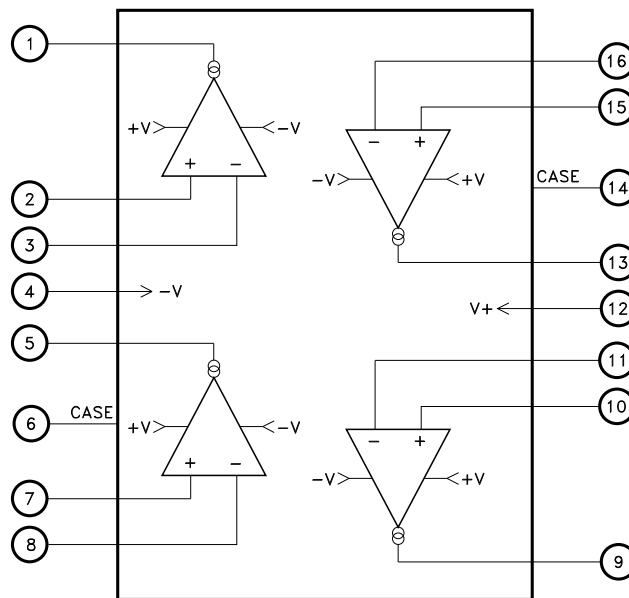

**TYPICAL APPLICATIONS**

- High Side or Low Side Current Sensing
- Current Monitoring on Positive or Negative Supply Voltages
- Battery Monitoring
- Fuse/MOSFET Monitoring
- Power Management

**PIN-OUT INFORMATION**

1 VOUT 1	16 -IN 4
2 +IN 1	15 +IN 4
3 -IN 1	14 CASE
4 V-	13 VOUT 4
5 VOUT 2	12 V+
6 CASE	11 -IN 3
7 +IN 2	10 +IN 3
8 -IN 2	9 VOUT 3

the Linear Technology logo and Over-the-Top are registered trademarks and RH6105 is a copyright of Linear Technology Corporation

## ABSOLUTE MAXIMUM RATINGS <sup>⑨</sup>

Input Voltage (+ IN, -IN to V-). . . . .-9.5V to 44V  
 Differential Input Voltage. . . . .44V  
 Total Supply Voltage from V-. . . . .36V  
 Output Short Circuit Duration. . . . . Indefinite<sup>④</sup>

T<sub>ST</sub> Storage Temperature Range <sup>⑫</sup> . . . . .-65°C to + 150°C  
 T<sub>LD</sub> Lead Temperature Range  
 (10 Seconds). . . . .300°C  
 T<sub>J</sub> Junction Temperature. . . . .150°C  
 T<sub>C</sub> Case Operating Temperature Range  
 MSK496KRH/HRH . . . . .-55°C to + 125°C  
 MSK496RH . . . . .-40°C to + 85°C  
 MSK496EDU <sup>⑪</sup> . . . . .-40°C to + 85°C  
 ESD Rating. . . . .Class 1B

## ELECTRICAL SPECIFICATIONS

Parameter	Test Conditions <sup>① ⑩</sup>	Group A Subgroup	MSK496KRH/HRH			MSK496RH/EDU			Units
			Min.	Typ.	Max.	Min.	Typ.	Max.	
Voltage Gain Error 1	V <sub>SENSE</sub> = 25mV to 75mV	1	-1	0.1	1	-1	-	+1	%
		2,3	-1.5	0.1	1.5	-	-	-	%
Voltage Gain Error 2	V <sub>SENSE</sub> = 25mV to 75mV V <sub>S+</sub> = 0	1,2,3	-4.25	-	+2.25	-4.25	-	+2.25	%
		1	-4.5	-	+4.5	-4.5	-	+4.5	%
Input Offset Voltage 1	V <sub>SENSE</sub> = 25mV, V <sub>S+</sub> = 12V	1	-0.4	-0.1	0.4	-0.4	-0.1	-0.4	mV
		2,3	-0.9	-	0.9	-	-	-	mV
		1	-1.0	-	1.0	-1.0	-	1.0	mV
		1	-2.0	-	1.0	-2.0	-	1.0	mV
Input Offset Voltage 2	V <sub>SENSE</sub> = 5mV; V <sub>S+</sub> = 0V	1	-1	-0.3	1	-1	-0.3	1	mV
		2,3	-1.6	-	1.6	-	-	-	mV
		1	-1.2	-	1.2	-1.2	-	1.2	mV
Input Common Mode Rejection Ratio	V <sub>SENSE</sub> = 5mV; V <sub>S+</sub> = 2.8V to 44V	4	100	120	-	100	120	-	dB
		5,6	95	-	-	-	-	-	dB
		4	90	-	-	90	-	-	dB
Power Supply Rejection Ratio	V <sub>SENSE</sub> = 5mV; V <sub>+</sub> = 2.85 to 36V	4	98	120	-	98	120	-	dB
		5,6	94	-	-	-	-	-	dB
		4	90	-	-	90	-	-	dB
Input Current <sup>③</sup>	V <sub>SENSE</sub> = 0V; V <sub>S+</sub> = 3V; A <sub>V</sub> = 25 V <sub>SENSE</sub> = 0V; V <sub>S+</sub> = 0V	1,2,3	-	18	30	-	18	30	uA
		-	-	-0.05	-	-	-0.05	-	uA
Input Offset Current <sup>③</sup>	V <sub>SENSE</sub> = 0V; V <sub>S+</sub> = 3V; A <sub>V</sub> = 25 V <sub>SENSE</sub> = 0V; V <sub>S+</sub> = 0V	1,2,3	-	0.35	0.8	-	0.35	0.8	uA
		-	-	0.1	-	-	0.1	-	uA
V+ Supply Current	V <sub>SENSE</sub> = 0V; V <sub>S+</sub> = 3V; V <sub>+</sub> = 36V	1,2,3	-	780	1800	-	780	1800	uA
Minimum Output Voltage	V <sub>SENSE</sub> = 0mV; V <sub>S+</sub> = 44V; V <sub>+</sub> = 36V	1,2,3	-	-	45	-	-	45	mV
Output High (Referred to V+)	V <sub>SENSE</sub> = 120mV; A <sub>V</sub> = 100; R <sub>OUT</sub> = 10K	1,2,3	-	1.3	1.7	-	1.3	1.7	V
-3dB Bandwidth <sup>③</sup>	V <sub>SENSE</sub> = 50mV; A <sub>V</sub> = 10V/V	-	-	100	-	-	100	-	kHz
Thermal Resistance (Each Amplifier) <sup>②</sup>	Junction to Case @ 125°C	-	-	7.3	9.6	-	7.3	9.6	°C/W

### NOTES:

- ① Unless otherwise specified; V<sub>+</sub> = 12V, V<sub>-</sub> = 0V, V<sub>S+</sub> = 12V, R<sub>IN1</sub> = R<sub>IN2</sub> = 100Ω, R<sub>OUT</sub> = 5K(A<sub>V</sub> = 50), V<sub>SENSE</sub> = (V<sub>S+</sub>) - (V<sub>S-</sub>).
- ② Guaranteed by design but not tested.
- ③ Typical parameters are representative of device performance but are for reference only.
- ④ A heat sink may be required to keep the junction temperature below absolute maximum ratings.
- ⑤ Industrial grade devices shall be tested to subgroup 1 and 4 unless otherwise specified.
- ⑥ Military grade devices ("H" and "K" suffix) shall be 100% tested to subgroups 1,2,3, and 4
- ⑦ Subgroup 5 & 6 testing available upon request.
- ⑧ Subgroup 1,4 TC = +25°C  
 Subgroup 2,5 TC = +125°C  
 Subgroup 3,6 TC = -55°C
- ⑨ Continuous operation at or above absolute maximum ratings may adversely affect the device performance and/or life cycle.
- ⑩ Pre and post irradiation limits at 25°C, up to 100 Krad(Si) TID (Condition A) and 50 Krad(Si) TID (Condition D), are identical unless otherwise specified.
- ⑪ MSK496EDU does not use Rad Hard die, post irradiation specifications are not applicable.
- ⑫ Internal solder reflow temperature is 180°C, do not exceed.

## APPLICATION NOTES

### PIN FUNCTIONS

**-INx** - The -IN pin is the negative input terminal of the sense amplifier. Voltages as high as 44V can be applied to the pin, relative to the negative supply pin V-.

**+INx** - The +IN pin is the positive input terminal of the sense amplifier. Voltages as high as 44V can be applied to the pin, relative to the negative supply pin V-.

**V+** - The V+ pin is the positive power supply for all amplifiers. Operational currents are sourced from this pin independent of the voltages on the -IN and +IN pins.

**V-** - The V- pin is the negative power supply for all amplifiers. Connect to the negative supply voltage or circuit ground for single supply operation.

**VOUTx** - The VOUT pin is the output of the amplifier. The voltage at the output is a function of both the input differential ( $V_{SENSE} \pm V_{OS}$ ), and the voltage gain  $R_{OUT}/R_{IN1}$ , for  $R_{IN1} = R_{IN2}$ . (See typical application ckt for more detail)

$$V_{OUT} = R_{OUT}/R_{IN} \times (V_{SENSE} \pm V_{OS})$$

Set  $R_{IN1} = R_{IN2}$  for best accuracy

**CASE** - Pins 6 and 14 provide an electrical connection to the device package only. These pins are isolated from the internal circuit. Tie to a low impedance source or system ground to minimize coupling between amplifiers.

### SENSE RESISTOR

Choose a  $R_{SENSE}$  resistor value just large enough to cover the application dynamic range to minimize power dissipation losses. The low  $100\mu V$  typical offset voltage helps to maintain high resolution while minimizing power dissipation.

Kelvin connection of the input resistors to the sense resistor is recommended to minimize error in high current applications.

### TYPICAL APPLICATION CKT

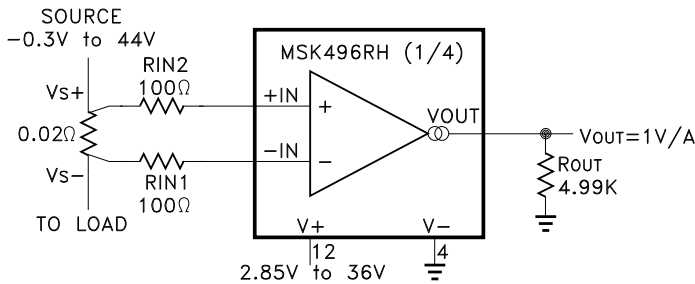

$$V_{OUT} = ((V_{S+}) - (V_{S-})) \cdot \frac{R_{OUT}}{R_{IN}}; A_v = \frac{R_{OUT}}{R_{IN}}; R_{IN1} = R_{IN2} = R_{IN}$$

### RADIATION TEST PERFORMANCE

Radiation performance curves have been generated for all radiation testing performed by MS Kennedy. These curves show performance trends throughout each test process and are located in the MSK196RH radiation test report. The complete radiation test report is available in the RAD HARD PRODUCTS section on the MSK website.

### ADDITIONAL APPLICATION INFORMATION

For additional applications information, please reference Linear Technology Corporation's® LT6105 data sheet.

### HIGH VOLTAGE SENSING

For high voltage applications, the MSK496RH can be used with external MOSFETs. The MOSFETs protect the device from the full potential of the high voltage supply. The high voltage supply is the positive rail of the device, and the Zener voltage minus the  $V_{GS(on)}$  potential of Q2 determines the negative voltage rail for the device;  $(V-) = (V+) - (V_Z - V_{GS})$ . The device can safely sense current from 0.3V below the negative rail up to 44V above it independent of high voltage supply, and deliver a ground referenced signal via Q1. The values in the application circuit are provided for reference. They may need to be adjusted based on specific application requirements.

### HIGH VOLTAGE SIMPLE CURRENT MONITOR

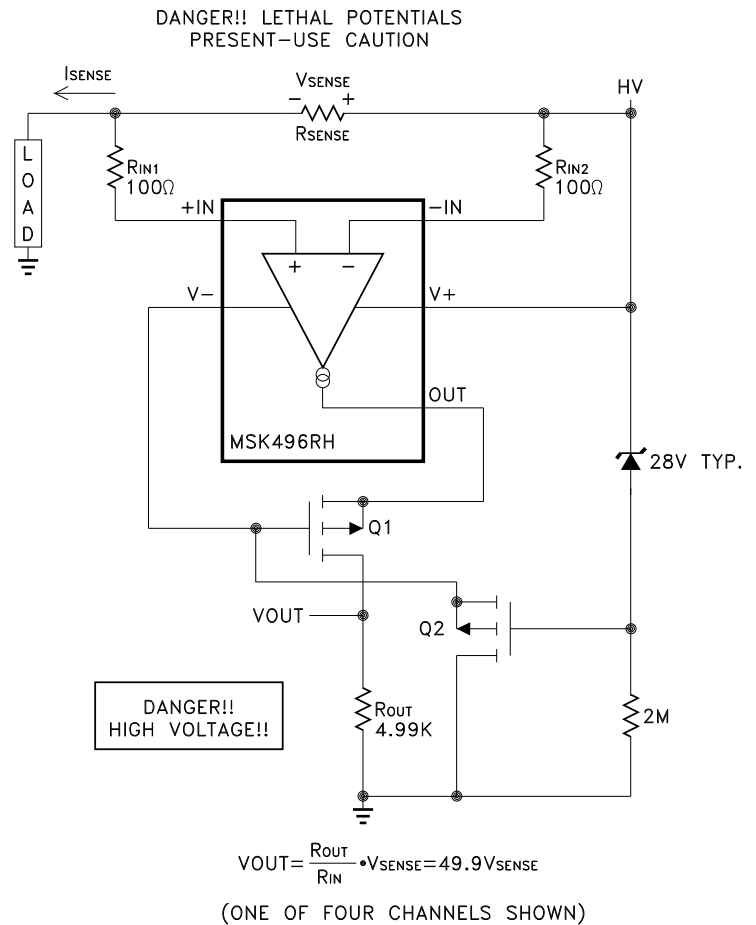

# TYPICAL PERFORMANCE CURVES

GAIN ERROR vs INPUT VOLTAGE

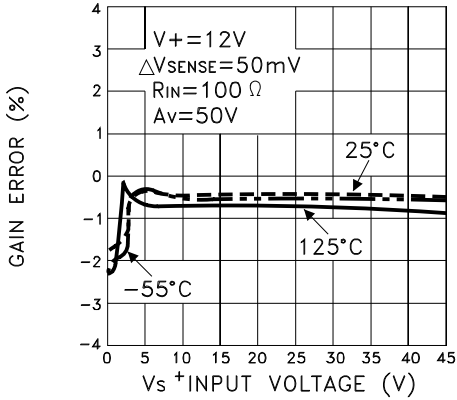

OUTPUT VOLTAGE vs  $V_{SENSE}$  VOLTAGE;  $V_{S+} = 0V$

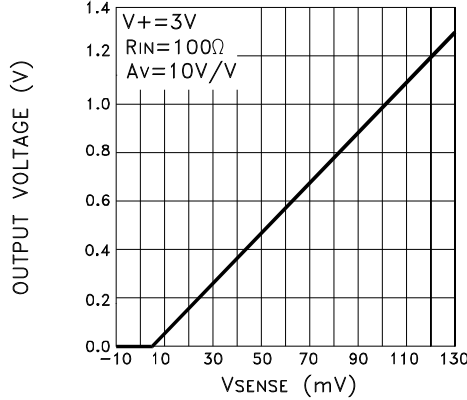

OUTPUT SATURATION VOLTAGE vs OUTPUT CURRENT  $V_{S+} = 12V$

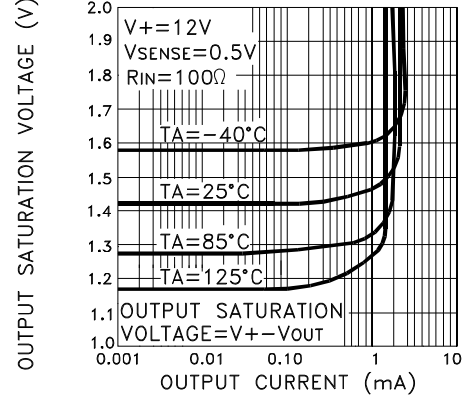

OUTPUT SATURATION VOLTAGE vs OUTPUT CURRENT  $V_{S+} = 0.5V$

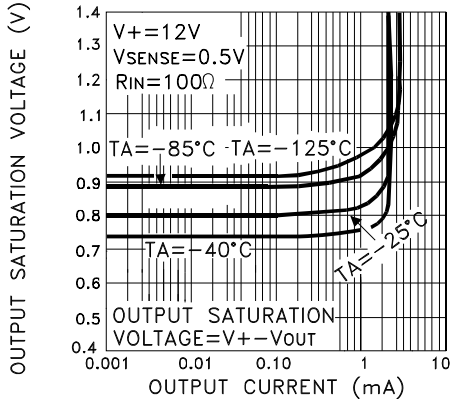

OUTPUT SHORT-CIRCUIT CURRENT vs TEMPERATURE

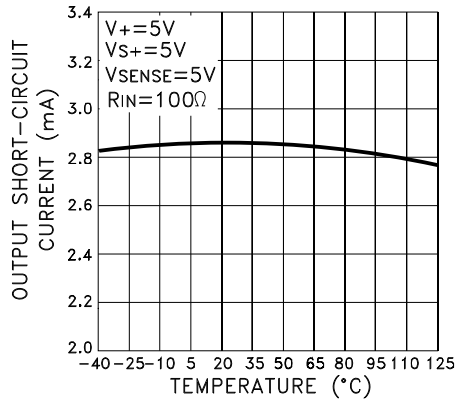

GAIN vs FREQUENCY

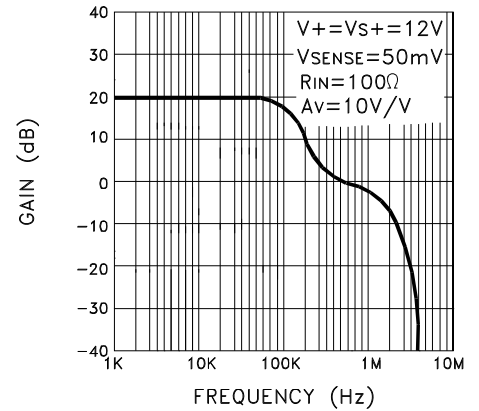

COMMON MODE REJECTION RATIO vs FREQUENCY

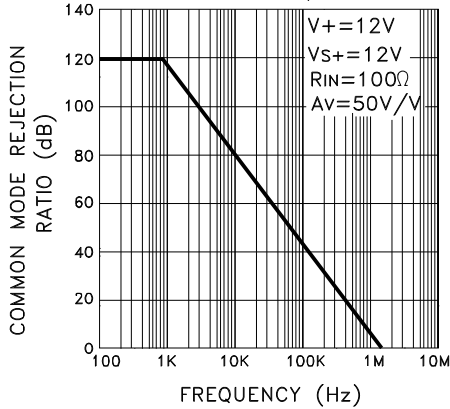

POWER SUPPLY REJECTION RATIO vs FREQUENCY

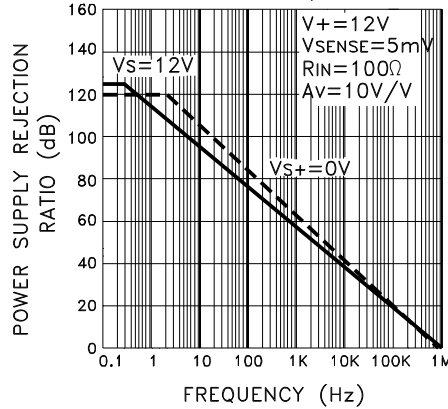

**MECHANICAL SPECIFICATIONS**

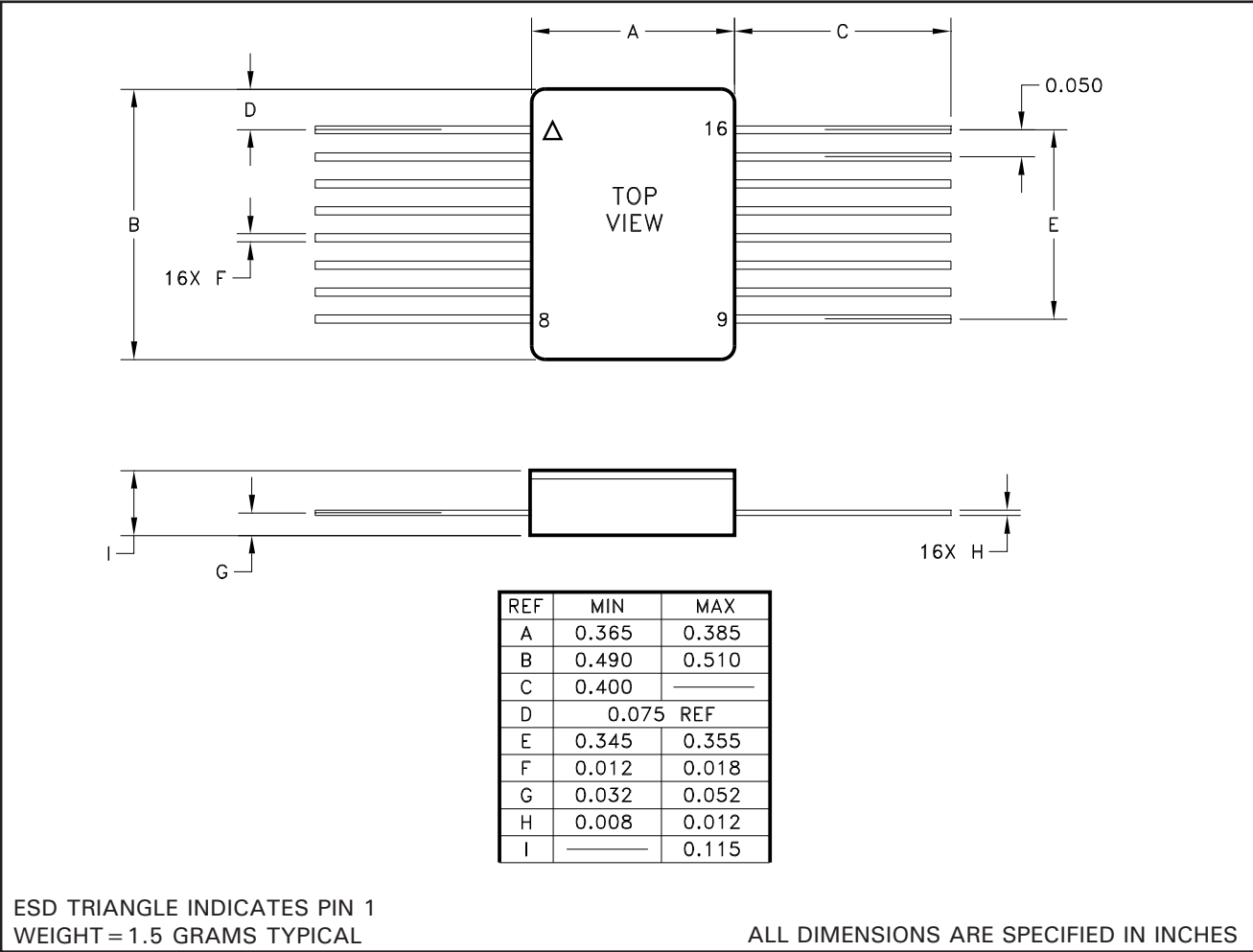

**ORDERING INFORMATION**

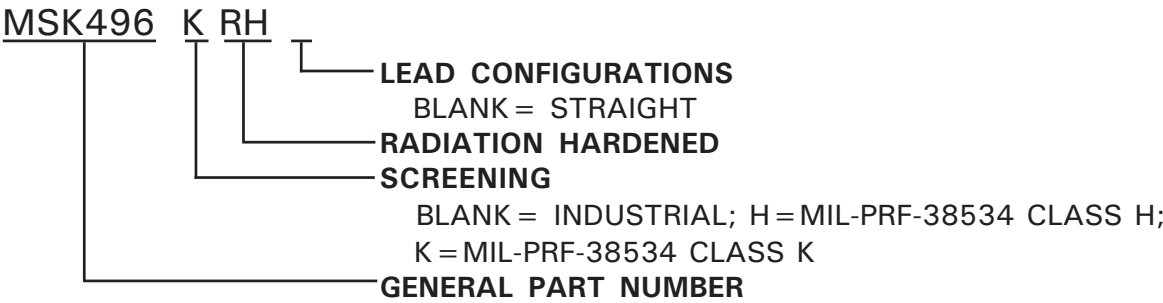

The above example is a Class K screened device with straight leads.  
 For Non-Rad Hard engineering units, order MSK496EDU.

## MECHANICAL SPECIFICATIONS

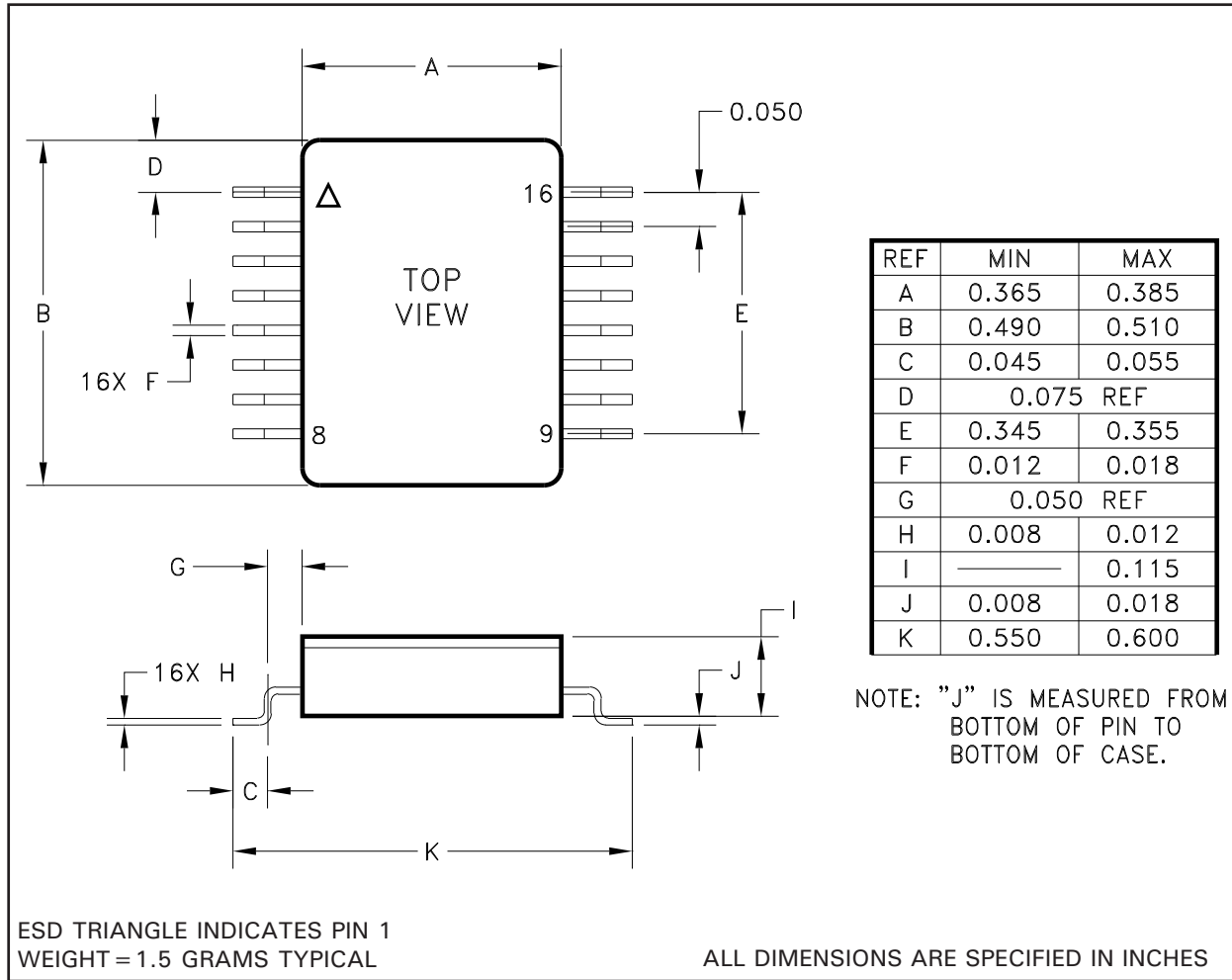

## ORDERING INFORMATION

**MSK496** **K** **RH** **G**

**LEAD CONFIGURATIONS**  
G = GULL WING

**RADIATION HARDENED**

**SCREENING**  
BLANK = INDUSTRIAL; H = MIL-PRF-38534 CLASS H;  
K = MIL-PRF-38534 CLASS K

**GENERAL PART NUMBER**

The above example is a Class K screened device with gull wing lead form.  
For Non-Rad Hard engineering units, order MSK496EDUG.

## REVISION HISTORY

REV	STATUS	DATE	DESCRIPTION
F	Released	04/14	Add low dose rate test bullet and adjust VOS1 post rad specifications.
G	21078	05/14	Revise V+ supply current and shutdown input current typical values.
H	21116	06/14	Add ESD rating.
I	21374	10/14	Revise R0JC.

M.S. Kennedy Corp.  
Phone (315) 701-6751  
FAX (315) 701-6752  
[www.mskennedy.com](http://www.mskennedy.com)

---

The information contained herein is believed to be accurate at the time of printing. MSK reserves the right to make changes to its products or specifications without notice, however, and assumes no liability for the use of its products. Please visit our website for the most recent revision of this datasheet.